



1510 – B Third Street
Tillamook, Oregon 97141
www.tillamook.or.us
Building (503) 842-3407
Planning (503) 842-3408
Sanitation (503) 842-3409
FAX (503) 842-1819
Toll Free 1(800) 488-8280

Land of Cheese, Trees and Ocean Breeze

**VARIANCE REQUEST #851-25-000096-PLNG:
Oregon Department of Forestry
Verizon Communications Facility**

*NOTICE TO MORTGAGEE, LIENHOLDER, VENDOR OR SELLER:
ORS 215 REQUIRES THAT IF YOU RECEIVE THIS NOTICE,
IT MUST BE PROMPTLY FORWARDED TO THE PURCHASER*

**NOTICE OF ADMINISTRATIVE REVIEW
Date of Notice: March 31, 2025**

Notice is hereby given that the Tillamook County Department of Community Development is considering the following:

#851-25-000096-PLNG: A Variance request to reduce the required 30-foot property line setback to 4-feet 7-inches for the siting of a new wireless communications facility. Located northeast of the Unincorporated Community of Siskeyville, the subject property is located at 300 Muesial Creek Road and is designated as Tax Lot 400 of Section 25, Township 1 North, Range 8 West of the Willamette Meridian, Tillamook County, Oregon. The property is zoned Forest (F). The applicant is Tessie Murakami, and the property owner is the State of Oregon Department of Forestry.

Written comments received by the Department of Community Development prior to 4:00 p.m. on April 14, 2025, will be considered in rendering a decision. Comments should address the criteria upon which the Department must base its decision. Notice of the application, a map of the subject area, and the applicable criteria are being mailed to all property owners within 750-feet of the exterior boundaries of the subject parcel for which an application has been made and other appropriate agencies at least 14-days prior to this Department rendering a decision on the request. A decision will be rendered no sooner than April 15, 2025.

A copy of the application, along with a map of the request area and the applicable criteria for review are available for inspection at the Department of Community Development office located at 1510-B Third Street, Tillamook, Oregon 97141. They are also available on the Tillamook County Department of Community Development website: <https://www.co.tillamook.or.us/commdev/landuseapps>.

If you have any questions about this application, please contact the Department of Community Development at (503) 842-3408 or by contacting Sarah Thompson, Office Specialist, at Sarah.thompson@tillamookcounty.gov. Comments can be emailed to Sarah Thompson, Office Specialist, at Sarah.thompson@tillamookcounty.gov.

Sincerely,

Sarah Absher, CFM, Director

Enc. Maps and Applicable Ordinance criteria

REVIEW CRITERIA

ARTICLE VIII - VARIANCE PROCEDURES AND CRITERIA

SECTION 8.030: REVIEW CRITERIA: A VARIANCE shall be granted, according to the procedures set forth in Section

8.020, if the applicant adequately demonstrates that the proposed VARIANCE satisfies all of the following criteria:

- (1) Circumstances attributable either to the dimensional, topographic, or hazardous characteristics of a legally existing lot, or to the placement of structures thereupon, would effectively preclude the enjoyment of a substantial property right enjoyed by the majority of landowners in the vicinity, if all applicable standards were to be met. Such circumstances may not be self-created.
- (2) A VARIANCE is necessary to accommodate a use or accessory use on the parcel which can be reasonably expected to occur within the zone or vicinity.
- (3) The proposed VARIANCE will comply with the purposes of relevant development standards as enumerated in Section 4.005 and will preserve the right of adjoining property owners to use and enjoy their land for legal purposes.
- (4) There are no reasonable alternatives requiring either a lesser or no VARIANCE.

SECTION 4.005: RESIDENTIAL AND COMMERCIAL ZONE STANDARDS

PURPOSE: In all RESIDENTIAL AND COMMERCIAL ZONES, the purpose of land use standards are the following:

- (1) To ensure the availability of private open space;
- (2) To ensure that adequate light and air are available to residential and commercial structures;
- (3) To adequately separate structures for emergency access;
- (4) To enhance privacy for occupants of residences;
- (5) To ensure that all private land uses that can be reasonably expected to occur on private land can be entirely accommodated on private land, including but not limited to dwellings, shops, garages, driveways, parking, areas for maneuvering vehicles for safe access to common roads, alternative energy facilities, and private open spaces;
- (6) To ensure that driver visibility on adjacent roads will not be obstructed;
- (7) To ensure safe access to and from common roads;
- (8) To ensure that pleasing views are neither unreasonably obstructed nor obtained;
- (9) To separate potentially incompatible land uses;
- (10) To ensure access to solar radiation for the purpose of alternative energy production.

VICINITY MAP

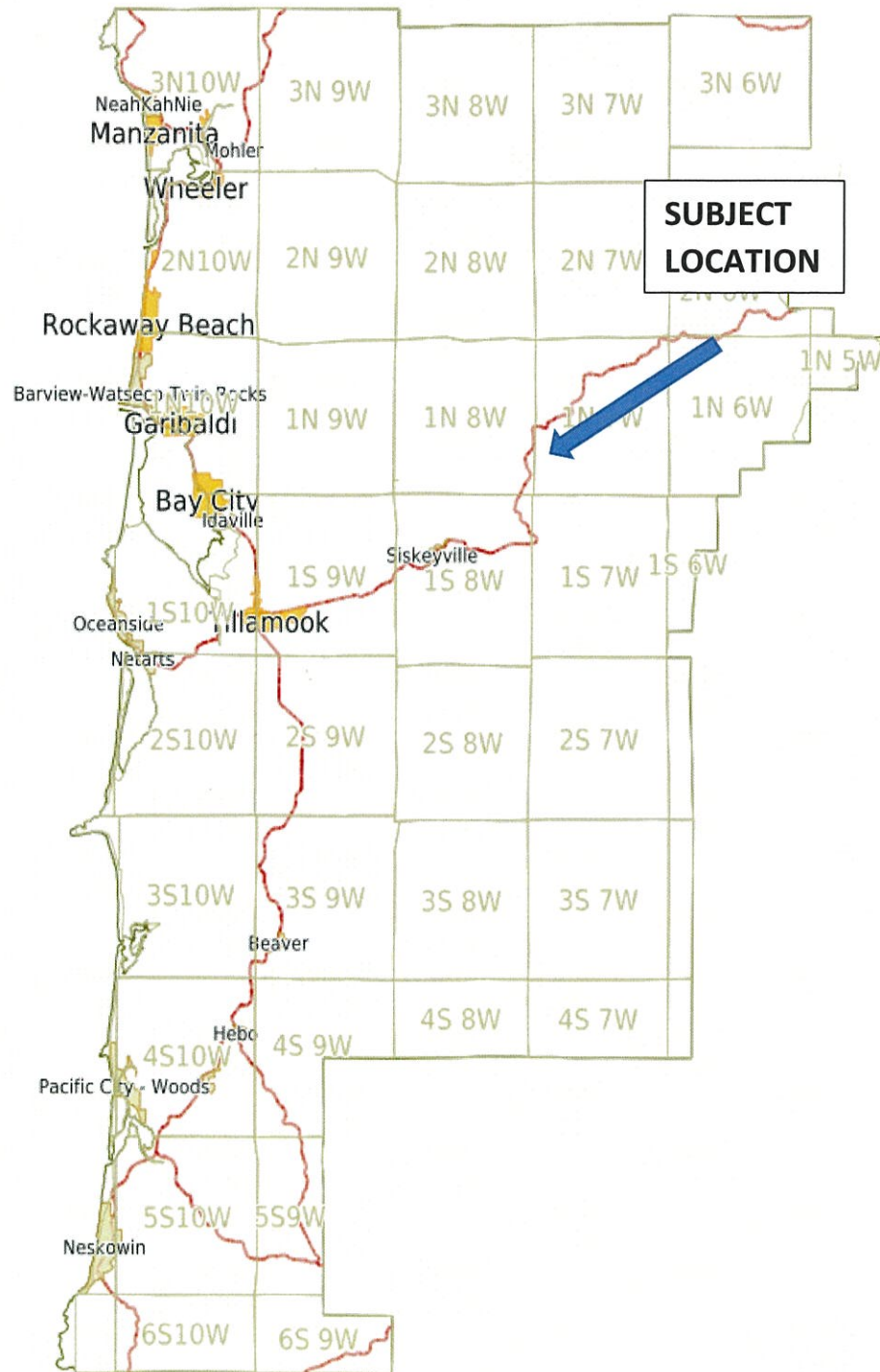

#851-25-000096-PLNG: Communications Facility
Variance Request

FOR ASSESSMENT AND TAXATION ONLY. NOT SUITABLE FOR
LEGAL, ENGINEERING, OR SURVEY PURPOSES

SECTION 25 T.1N. R.8W. W.M.
Tillamook County

1" = 400'

01N08W25

CANCELLED

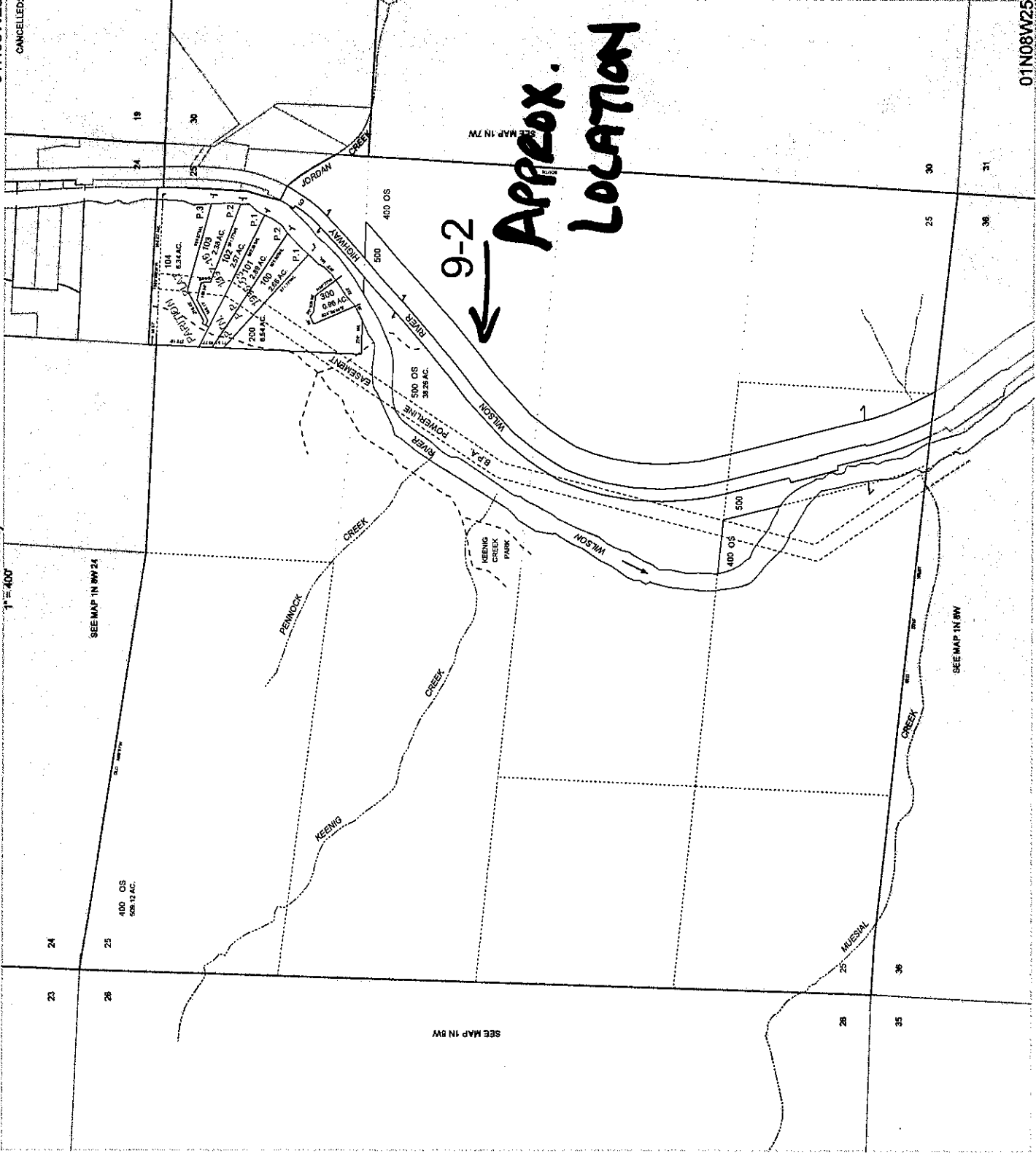

01N08W25

REVISED 2/16/16, WS

Map

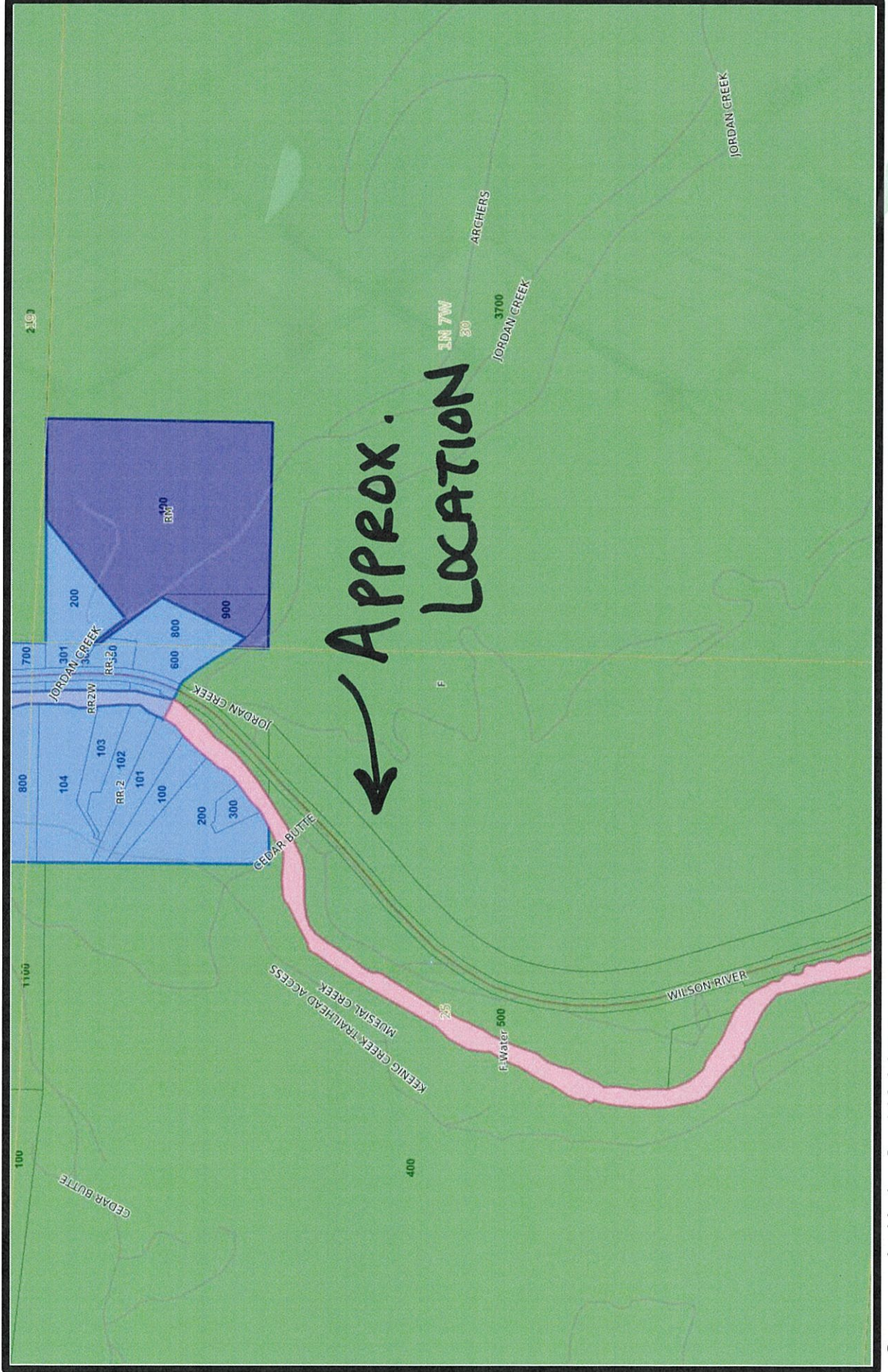



Tillamook County Department of Community Development
1510-B Third Street, Tillamook, OR 97141 | Tel: 503-842-3408 Fax: 503-842-1819
www.co.tillamook.or.us

PLANNING APPLICATION

Applicant (Check Box if Same as Property Owner)

Name: **Sarah Blanchard** Phone: **503.310.0544**

Address: 5200 SW Meadows Rd., Suite 150 *Tessie Mufakami 310.483.5343*

City: Lake Oswego State: OR Zip: 97035

Email: sarah.blanchard@acomconsultinginc.com

Property Owner

Name: Oregon Dept. of Forestry (ODF) Phone: Zach Rabe - 503-842-2545

Address: 5005 3rd Street

City: Tillamook State: OR Zip: 97141

Email: Zach.D.RABE@odf.oregon.gov

OFFICE USE ONLY	
Date Stamp	
RECEIVED	
FEB 21 2025	
BY: <i>[Signature]</i>	
<input type="checkbox"/> Approved	<input type="checkbox"/> Denied
Received by:	
Receipt #:	
Fees:	
Permit No:	
851- <i>25</i> - <i>000916</i> -PLNG	

Variance
Request: Type II Conditional Use Review for a new wireless communications facility (with Verizon Wireless as tenant carrier) on forest parcel.
HWY 6 node 7
HWY 6 node 7

- | Type II | Type III | Type IV |
|--|---|---|
| <input type="checkbox"/> Farm/Forest Review | <input type="checkbox"/> Detailed Hazard Report | <input type="checkbox"/> Ordinance Amendment |
| <input type="checkbox"/> Conditional Use Review | <input type="checkbox"/> Conditional Use (As deemed by Director) | <input type="checkbox"/> Large-Scale Zoning Map Amendment |
| <input checked="" type="checkbox"/> Variance | <input type="checkbox"/> Ordinance Amendment | <input type="checkbox"/> Plan and/or Code Text Amendment |
| <input type="checkbox"/> Exception to Resource or Riparian Setback | <input type="checkbox"/> Map Amendment | |
| <input type="checkbox"/> Nonconforming Review (Major or Minor) | <input type="checkbox"/> Goal Exception | |
| <input type="checkbox"/> Development Permit Review for Estuary Development | <input type="checkbox"/> Nonconforming Review (As deemed by Director) | |
| <input type="checkbox"/> Non-farm dwelling in Farm Zone | <input type="checkbox"/> Variance (As deemed by Director) | |
| <input type="checkbox"/> Foredune Grading Permit Review | | |
| <input type="checkbox"/> Neskowin Coastal Hazards Area | | |

Location:

Site Address: 35300 Wilson River Hwy, Tillamook, OR 97141 (309927/1N08250000400)

Map Number: 1N	8W	25	0400
Township	Range	Section	Tax Lot(s)

Clerk's Instrument #: _____

Authorization

This permit application does not assure permit approval. The applicant and/or property owner shall be responsible for obtaining any other necessary federal, state, and local permits. The applicant verifies that the information submitted is complete, accurate, and consistent with other information submitted with this application.

Property Owner Signature (Required)	Digitally signed by Zachariah Rabe	Date
Zachariah Rabe	Date: 2025.02.14 11:43:56 -08'00'	

Applicant Signature	Applicant	Date
<i>[Signature]</i>		2/14/25

**LAND USE APPLICATION -
VARIANCE**

**VERIZON WIRELESS
TELECOMMUNICATIONS
FACILITY AT**

No Situs
Tillamook, OR 97141
(Acct 309927/Map Tax
Lot 1N08250000400)

Prepared By



Date
February 17, 2025

Project Name
POR HWY 6 - 07



I. GENERAL INFORMATION

Applicant: Verizon Wireless
5430 NE 122nd Avenue
Portland, OR 97230

Representative: Acom Consulting, Inc.
Tessie Murakami
5200 SW Meadows Rd., Suite 150
Lake Oswego, OR 97035

Property Owner: Oregon Dept. of Forestry
Zach Rabe
5005 3rd Street
Tillamook, OR 9141

Project Information:

Site Address: No Situs, Tillamook, OR 97141
Parcel: 1N08250000400
Account Number: 309927
Parcel Area: 509.12 acres
Zone Designation: F (Forest)
Existing Use: Forest
Project Area: 100 Square Feet (10' x 10') accessed by a short 10' wide access and utility easement.

II. PROJECT OVERVIEW

Acom Consulting is applying on behalf of Verizon Wireless, who will own and operate the tower and ground space; Cellco Partnership dba Verizon Wireless, who will be located on this facility and the property owner, Tillamook County. The site proposed herein is designed to improve the voice and data capacity for its customers in Tillamook County and along Highway 6. This is part of the initiative to provide better coverage of 911 calls on the highway since it is known as the deadly stretches in Oregon. The state is mandating all carriers to address the coverage gap at HWY OR-6.

The applicant proposes to construct a new wireless communications facility ("WCF") within a 10' x 10' ground lease area. This proposal includes a 80-foot monopole tower with up to 3 antennas at an antenna tip-height of 80' and associated RRU's, equipment cabinets, backup generator, and high security fence with 3 strands barbed wire. The site will be accessed via an existing driveway off HWY OR-6.

The monopole tower would be a metal pole and can be painted a non-reflective color to blend with the adjacent mature trees and sky. The proposed monopole (small cell) is only 80' and is a part of Verizon's small cells



project in Tillamook County which is requiring additional poles to be installed along HWY OR-6 for the proposal to provide adequate service coverage in the area.

This site was chosen because HWY OR-6 is currently significantly underserved by wireless coverage, even though there is a substantial amount of traffic every day. The lack of existing wireless facilities in the area contributes to lack of coverage. The newly proposed small cells will provide much needed coverage in areas that would be difficult to serve using conventional tower-based transmitters. These sites will not only help improve customer experience but also help public safety and emergency services by allowing communication in an otherwise cut-off area.

This site can meet the Tillamook County criteria for sitting of new wireless telecommunication facilities, including height, setbacks and design as demonstrated herein. As shown throughout this application, Verizon's proposal is the least intrusive means of meeting coverage objectives. The applicants respectfully request that Tillamook County approve the variance and facility as proposed.

III. PROPOSED PLAN

This is a variance request to reduce the required 30-foot property line setback to 4 ft. 7 inches to support the approved construction of the 80 ft. monopole tower to provide cellular service and coverage along the highway. The subject property is surrounded by Forest and highway traffic.

IV. APPLICABLE ORDINANCE AND COMPREHENSIVE PLAN PROVISIONS

- A. TCLUO Section 3.004 – Forest (F) Zone
- B. TCLUO Article VIII – Variance Procedures and Criteria - Section 8.030 Review Criteria

V. ANALYSIS

- A. TCLUO Section 3.004 – Forest (F) Zone

(1) PURPOSE

(a) The purpose of the Forest (F) Zone is to protect and maintain forest lands for grazing, and rangeland use and forest use, consistent with existing and future needs for agricultural and forest products. The F zone is also intended to allow other uses that are compatible with agricultural and forest activities, to protect scenic resources and fish and wildlife habitat, and to maintain and improve the quality of air, water and land resources of the county.

(b) The F zone has been applied to lands designated as Forest in the Comprehensive Plan. The provisions of the F zone reflect the forest land policies of the Comprehensive Plan



as well as the requirements of ORS Chapter 215 and OAR 660-006. The minimum parcel size and other standards established by this zone are intended to promote commercial forest operations.

Applicant's response: The proposed WCF is located in the Forest (F) zone.

(2) DEFINITIONS

Words used in the present tense include the future; the singular number includes the plural; and the word "shall" is mandatory and not directory. Whenever the term "this ordinance" is used herewith, it shall be deemed to include all amendments thereto as may hereafter from time to time be adopted.

For the purpose of this zone, the following definitions apply:

(dd) UTILITY FACILITIES NECESSARY FOR PUBLIC SERVICE: Unless otherwise specified in this Article, any facility owned or operated by a public, private or cooperative company for the transmission, distribution or processing of its products or for the disposal of cooling water, waste or by-products, and including, major trunk, pipelines, dams & and other hydroelectric facilities, water towers, sewage lagoons, cell towers, electrical transmission facilities (except transmission towers over 200' in height) including substations not associated with a commercial power generating facilities and other similar facilities.

Applicant's response: The proposed WCF qualifies as a utility facility necessary for public service.

B. TCLUO Article VIII – Variance Procedures and Criteria - Section 8.030 Review Criteria

SECTION 8.030: REVIEW CRITERIA

A VARIANCE shall be granted, according to the procedures set forth in Section 8.020, if the applicant adequately demonstrates that the proposed VARIANCE satisfies all of the following criteria:

- (1) Circumstances attributable either to the dimensional, topographic, or hazardous characteristics of a legally existing lot, or to the placement of structures thereupon, would effectively preclude the enjoyment of a substantial property right enjoyed by the majority of landowners in the vicinity, if all applicable standards were to be met. Such circumstances may not be self-created.

Applicant's response:

The proposed site for the 80-foot monopole was selected after careful consideration of the topographic features of the land. The terrain along Highway 6 presents challenges, such as uneven land or areas with limited elevation, which restrict the ability to place a taller tower that would otherwise meet coverage objectives. The 80-foot monopole represents an optimal height for ensuring coverage without imposing significant visual impact on the landscape or surrounding properties. The site's dimensions and natural features make this tower the most feasible solution for expanding service in this area.

The placement of the tower 4 feet and 7 inches from the highway is a critical factor in ensuring that the structure will effectively meet the coverage requirements. The unique topography and layout of the land make this location optimal for extending the network's range, ensuring strong and reliable service along



the highway. The tower must be positioned at this exact distance from the highway to take advantage of natural line-of-sight coverage, minimizing potential interference and maximizing signal strength. Further, no hazardous areas or conditions, such as flood zones or unstable terrain, would affect the tower installation. The precise distance of 4 feet and 7 inches ensures that the tower is positioned in a safe location relative to the highway, ensuring the safety of both the infrastructure and the surrounding community.

- (2) A VARIANCE is necessary to accommodate a use or accessory use on the parcel which can be reasonably expected to occur within the zone or vicinity.

Applicant's response:

A variance is necessary for the proposed 80-foot monopole tower to be positioned along Highway 6 to accommodate the wireless infrastructure needed to address the substantial coverage gap in the area. The variance will allow Verizon to place the monopole in a way that provides effective service coverage while complying with the unique topographic, dimensional, and zoning requirements of the parcel. Although the use of a telecommunications tower is generally reasonable and expected use within this zone or vicinity, the specific placement and dimensions required for the tower to function effectively call for a variance.

The installation of wireless telecommunications infrastructure, including monopole towers, is a reasonable and common use within this zone and vicinity, especially along major highways like Highway 6. The need for reliable mobile service—both for general users and for public safety communications—makes this infrastructure essential. However, due to the topography of the site and the need for the monopole to be positioned 4 feet and 7 inches from the highway to maximize signal effectiveness, the structure cannot conform to the standard 30 ft. setback requirements.

- (3) The proposed VARIANCE will comply with the purposes of relevant development standards as enumerated in Section 4.005 and will preserve the right of adjoining property owners to use and enjoy their land for legal purposes.

Applicant's response:

The proposed variance for the 80-foot monopole tower along Highway 6 will comply with the purposes of the relevant development standards as outlined in Section 4.005 of the zoning code. These standards are designed to ensure that new development is compatible with surrounding land uses, protects the health, safety, and welfare of the community, and minimizes negative impacts on neighboring properties.

The monopole's placement and height have been carefully considered to avoid any disruption to adjacent properties. The surrounding land is primarily in a forest zone, where telecommunications infrastructure is expected and compatible with the area's broader land-use goals. The monopole is not near residential properties and the height and location of the tower ensure it does not block light, air, or views in a way that would impact neighboring landowners' enjoyment of their property.

By ensuring the monopole is placed in a location that does not infringe on neighboring landowners' rights to use their property (such as by taking up excessive space or obstructing existing structures), the variance will not preclude the adjacent properties from being used for their intended legal purposes. The



monopole's small footprint and limited visibility ensure that it will not interfere with the enjoyment of adjoining landowners' properties.

(4) There are no reasonable alternatives requiring either a lesser or no VARIANCE.

Applicant's response:

The unique topography of the parcel plays a significant role in determining the location of the monopole. Due to natural land features such as elevation changes, slopes, and the layout of surrounding roads and properties, the placement of the tower in any other location would fail to meet the service coverage requirements or would cause excessive interference with the surrounding environment.

The terrain along Highway 6 restricts where the monopole can be placed for optimal coverage. Moving the tower away from the highway would result in a substantial reduction in coverage, as the signal strength would decrease significantly without the proper line of sight. This precise location, 4 feet and 7 inches from the highway, ensures that the tower can provide the necessary coverage for both travelers and residents while minimizing interference from nearby structures or topographic obstacles.

Further, the monopole must be placed as close as possible to the highway to ensure adequate coverage along this vital transportation corridor. Moving the tower further away from the highway would result in signal degradation and failure to meet Verizon's coverage objectives. Without the variance, the monopole could not achieve the necessary height, coverage, or line of sight required to serve the area effectively.

The requested variance for the 80-foot monopole tower is necessary because there are no reasonable alternatives that would meet the service needs of the area without requiring either a lesser or no variance. The unique topography, zoning restrictions, and engineering requirements dictate that the tower must be positioned 4 feet and 7 inches from the highway to provide the optimal coverage along Highway 6. Relocating the tower or attempting to reduce the variance would result in inadequate service coverage, failure to meet Verizon's technical requirements, and potential disruption to surrounding properties. Therefore, the proposed variance is the only feasible option to ensure the tower serves its intended purpose while minimizing impacts to the surrounding community.

Verizon respectfully request the County approve the Variance to the 30-ft setback.

verizon

HWY 6

MDG LC: 5000908253

SITE NAME: POR HWY 6 - 07
 ADDRESS: 35300 WILSON RIVER HWY
 TILLAMOOK, OR 97141
 COUNTY: TILLAMOOK
 JURISDICTION: TILLAMOOK COUNTY
 POLE TYPE: NEW METAL POLE
 POLE #: NA
 ANTENNA LOCATION: POLE MOUNTED

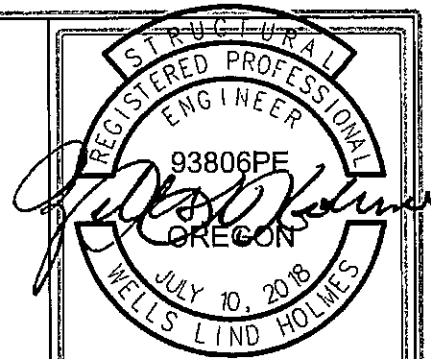

EXPIRES: 6/30/2025
 02/11/2025
 VSE Project Number: U2350-1241-241

NO.	DATE	DRAWN	REVISION
A	05/22/23	KM	90% PCD REVIEW
B	08/03/23	KM	SURVEY UPDATE
C	08/04/24	KM	RFDS UPDATE
D	12/11/24	DO	100% FINAL CD
1	01/27/25	KM	CLIENT COMMENTS
2	02/11/25	KM	CLIENT COMMENTS

VICINITY MAP

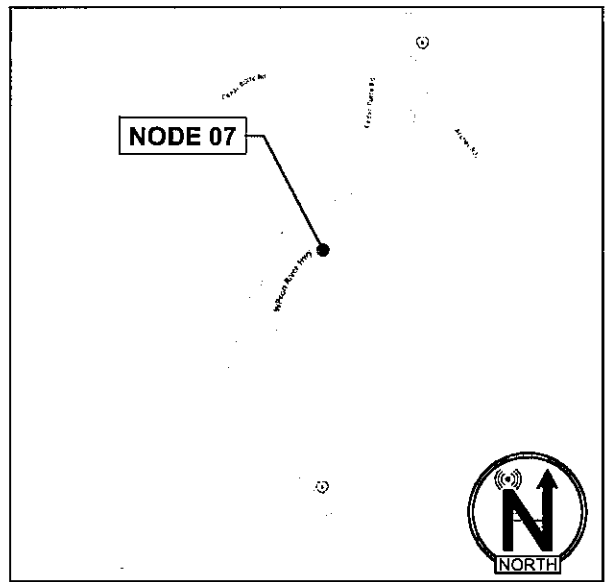

TOWER PHOTO

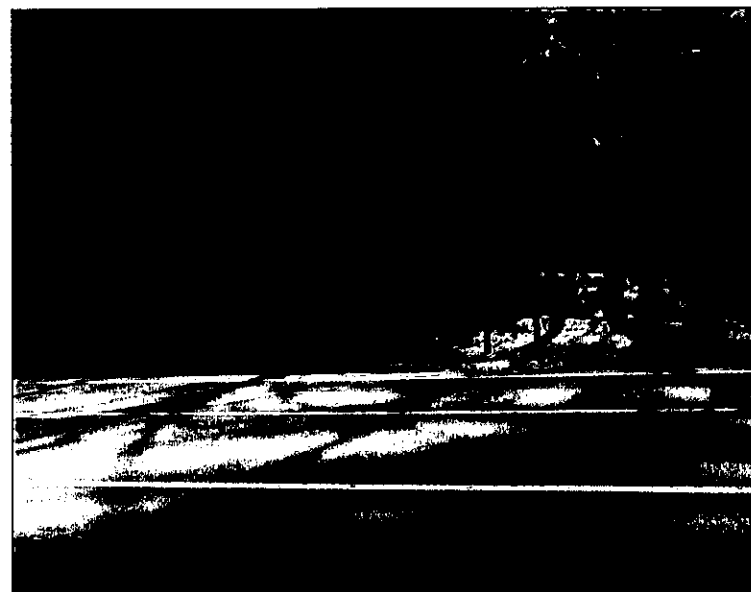

PROJECT CONTACT LIST

PROPERTY OWNER: OREGON DEPARTMENT OF FORESTRY
UTILITY TOWER OWNER: N/A
IMPLEMENTATION CONTACT: CHRISTOPHER LEWIS, VERIZON WIRELESS (VAW) LLC, 5430 NE 122ND AVENUE, PORTLAND, OR 97230, PHONE: (951) 796-5523, christopher.lewis2@verizonwireless.com
A&E CONSULTANT: RICK MATTESON, ACOM CONSULTING, INC, 5200 SW MEADOWS RD SUITE 150, LAKE OSWEGO, OR 97035, PHONE: (425) 209-6723, rick.matteson@acomconsultinginc.com
REAL ESTATE: SARAH BLANCHARD, ACOM CONSULTING, INC, 5200 SW MEADOWS RD, SUITE 150, LAKE OSWEGO, OR 97035, PHONE: (503) 310-5538, sarah.blanchard@acomconsultinginc.com
ZONING / PERMITTING: TESSIE MURAKAMI, ACOM CONSULTING, INC, 5200 SW MEADOWS RD, SUITE 150, LAKE OSWEGO, OR 97035, PHONE: (310) 483-5343, tessie.murakami@acomconsultinginc.com
ENGINEER OF RECORD: WELLS L. HOLMES, S.E., VECTOR STRUCTURAL ENGINEERING, 651 W GALENA PARK BLVD, SUITE 101, DRAPER, UT 84020, PHONE: (801) 990-1775
ELECTRICAL ENGINEER: DEAN P. LEVORSEN, P.E., VECTOR STRUCTURAL ENGINEERING, 651 W GALENA PARK BLVD, SUITE 101, DRAPER, UT 84020, PHONE: (801) 990-1775

DRAWING INDEX

- T-1 COVER SHEET
- T-2 GENERAL NOTES AND SYMBOLS
- C-00 GROUND & EROSION CONTROL PLAN
- C-01 SECTIONS, PROFILES & NOTES
- A-1.0 AERIAL IMAGE / SITE LOCATION
- A-2.0 ANTENNA & EQUIPMENT PLANS
- A-3.0 EXISTING AND PROPOSED ELEVATIONS
- A-4.0 CONSTRUCTION DETAILS
- A-5.0 CONSTRUCTION DETAILS
- A-6.0 ANTENNA DETAILS
- E-1.0 TYPICAL ONE-LINE DIAGRAM AND PANEL SCHEDULE
- RF-1 ANTENNA CONFIGURATION
- T-1 TOWER TITLE SHEET
- S-1 TOWER ELEVATION, DETAILS & NOTES
- S-2 TOWER DETAILS



LOCATION MAP

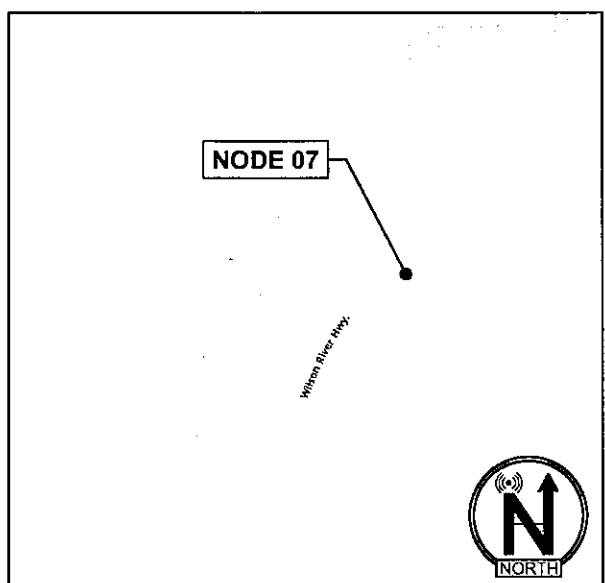

DRIVING DIRECTIONS

FROM VERIZON WIRELESS OFFICE - PORTLAND, OR:
 HEAD SOUTHWEST ON NE 122ND AVE TOWARD NE WHITAKER WAY. TURN RIGHT ONTO NE FREMONT ST. USE THE RIGHT LANE TO TURN LEFT ONTO NE 102ND AVE. TURN RIGHT TO MERGE ONTO I-84 W/US-30 W TOWARD PORTLAND. MERGE ONTO I-84 W/US-30 W. USE THE LEFT 2 LANES TO MERGE ONTO I-5 S TOWARD SALEM. USE THE LEFT LANE TO TAKE THE I-405 EXIT TOWARD US-26/BEAVERTON. CONTINUE ONTO I-405 N. USE THE RIGHT 2 LANES TO TAKE EXIT 1D FOR U.S. 26 W TOWARD BEAVERTON. CONTINUE ONTO US-26 W. SLIGHT LEFT ONTO OR-6 W (SIGNS FOR BANKS/TILLAMOOK). FOLLOW FOR 33.6 MILES. DESTINATION WILL BE ON THE LEFT ROUGHLY 300 FEET AFTER MILE MARKER 18.

CODE COMPLIANCE

ALL WORK AND MATERIALS SHALL BE PERFORMED AND INSTALLED IN ACCORDANCE WITH THE CURRENT CONDITIONS OF THE FOLLOWING CODES AS ADOPTED BY THE LOCAL GOVERNING AUTHORITIES. NOTHING IN THESE PLANS IS TO BE CONSTRUED TO PERMIT WORK NOT CONFORMING TO THESE CODES:
 OREGON STATE AND LOCAL BUILDING CODES WITH THE FOLLOWING REFERENCE CODE:
 2021 IBC, STANDARDS AND AMENDMENTS - 2022 OSSC
 2022 OREGON MECHANICAL SPECIALTY CODE (OMSC)
 2021 IFC, STANDARDS AND AMENDMENTS - 2022 OFC
 2021 UPC, STANDARDS AND AMENDMENTS - 2021 OPSC
 2020 NEC, STANDARDS AND AMENDMENTS - 2021 OESC

PROJECT INFORMATION

JURISDICTION: TILLAMOOK COUNTY
 ZONING CLASSIFICATION: F - FOREST
 ADJACENT ZONE: R-6
 CONSTRUCTION TYPE: UTILITY
 PROPOSED BUILDING USE: TELECOM
 PROPOSED STRUCTURE HEIGHT: 80.0' (TOP OF NEW POLE)
 LATITUDE: 45.546270° N
 45° 32' 46.57" N
 LONGITUDE: -123.603734° W
 123° 36' 13.44" W
 GROUND ELEVATION: ±371.6 AMSL

SCOPE OF WORK

- VERIZON WIRELESS PROPOSES TO:
- PROPOSES TO INSTALL WIRELESS EQUIPMENT IN FENCED COMPOUND LOCATED OUTSIDE R-O-W
 - PROPOSES TO INSTALL (4) NEW ANTENNAS & (1) NEW MOUNT ON NEW POLE
 - PROPOSES TO INSTALL (1) NEW SMALL CELL CABINET ON CONCRETE PAD
 - PROPOSES TO INSTALL (1) NEW HYBRID AND APPROVED CABLE STRAP MOUNTED ON NEW POLE

DO NOT SCALE DRAWINGS. CONTRACTOR MUST VERIFY ALL DIMENSIONS AND ADVISE CONSULTANTS OF ANY ERRORS OR OMISSIONS. NO VARIATIONS OR MODIFICATIONS TO WORK SHOWN SHALL BE IMPLEMENTED WITHOUT PRIOR WRITTEN APPROVAL. ALL PREVIOUS ISSUES OF THIS DRAWING ARE SUPERSEDED BY THE LATEST REVISION. ALL DRAWINGS AND SPECIFICATIONS REMAIN THE PROPERTY OF ACOM CONSULTING.

**HWY 6
 SMALL CELL NODE 07**
 35300 WILSON RIVER HWY
 TILLAMOOK, OR 97141

COVER SHEET

T-1

GENERAL NOTES

- WORK SHALL COMPLY WITH ALL APPLICABLE CODES, ORDINANCES, AND REGULATIONS. ALL NECESSARY LICENSES, CERTIFICATES, ETC., REQUIRED BY AUTHORITY HAVING JURISDICTION SHALL BE PROCURED AND PAID FOR BY THE CONTRACTOR.
- ACOM HAS NOT CONDUCTED, NOR DOES IT INTEND TO CONDUCT ANY INVESTIGATION AS TO THE PRESENCE OF HAZARDOUS MATERIAL, INCLUDING, BUT NOT LIMITED TO, ASBESTOS WITHIN THE CONFINES OF THIS PROJECT. ACOM DOES NOT ACCEPT RESPONSIBILITY FOR THE INDEMNIFICATION, THE REMOVAL, OR ANY EFFECTS FROM THE PRESENCE OF THESE MATERIALS. IF EVIDENCE OF HAZARDOUS MATERIALS IS FOUND, WORK IS TO BE SUSPENDED AND THE OWNER NOTIFIED. THE CONTRACTOR IS NOT TO PROCEED WITH FURTHER WORK UNTIL INSTRUCTED BY THE OWNER IN WRITING.
- ALL MATERIAL FURNISHED UNDER THIS CONTRACT SHALL BE PROPOSED, UNLESS OTHERWISE NOTED. ALL WORK SHALL BE GUARANTEED AGAINST DEFECTS IN MATERIALS AND WORKMANSHIP. THE CONTRACTOR SHALL REPAIR OR REPLACE AT HIS EXPENSE ALL WORK THAT MAY DEVELOP DEFECTS IN MATERIALS OR WORKMANSHIP WITHIN SAID PERIOD OF TIME OR FOR ONE YEAR AFTER THE FINAL ACCEPTANCE OF THE ENTIRE PROJECT, WHICHEVER IS GREATER.
- THE GENERAL CONTRACTOR AND EACH SUBCONTRACTOR SHALL BE RESPONSIBLE FOR VERIFYING ALL EXISTING CONDITIONS AND UTILITIES AT THE JOB SITE BEFORE WORK IS STARTED. NO CLAIMS FOR EXTRA COMPENSATION FOR WORK WHICH COULD HAVE BEEN FORESEEN BY AN INSPECTION, WHETHER SHOWN ON THE CONTRACT DOCUMENTS OR NOT, WILL BE ACCEPTED OR PAID.
- THE GENERAL CONTRACTOR AND EACH SUBCONTRACTOR SHALL BE RESPONSIBLE FOR VERIFYING DIMENSIONS AND CONDITIONS AT THE JOB SITE WHICH COULD AFFECT THE WORK UNDER THIS CONTRACT. ALL MANUFACTURERS RECOMMENDED SPECIFICATIONS, EXCEPT THOSE SPECIFICATIONS HEREIN, WHERE MOST STRINGENT SHALL BE COMPLIED WITH.
- THE CONTRACTOR SHALL VERIFY AND COORDINATE SIZE AND LOCATION OF ALL OPENINGS FOR STRUCTURAL, MECHANICAL, ELECTRICAL, PLUMBING, CIVIL, OR ARCHITECTURAL WORK.
- THE CONTRACTOR SHALL VERIFY THAT NO CONFLICTS EXIST BETWEEN THE LOCATIONS OF ANY AND ALL MECHANICAL, ELECTRICAL, PLUMBING, OR STRUCTURAL ELEMENTS, AND THAT ALL REQUIRED CLEARANCES FOR INSTALLATION AND MAINTENANCE ARE MET. NOTIFY THE CONSULTANT OF ANY CONFLICTS. THE CONSULTANT HAS THE RIGHT TO MAKE MINOR MODIFICATIONS IN THE DESIGN OF THE CONTRACT WITHOUT THE CONTRACTOR GETTING ADDITIONAL COMPENSATION.
- DO NOT SCALE THE DRAWINGS. DIMENSIONS ARE EITHER TO THE FACE OF FINISHED ELEMENTS OR TO THE CENTER LINE OF ELEMENTS, UNLESS NOTED OTHERWISE. CRITICAL DIMENSIONS SHALL BE VERIFIED AND NOTIFY THE CONSULTANT OF ANY DISCREPANCIES.
- THE CONTRACTOR SHALL BE RESPONSIBLE FOR DAILY CLEAN UP OF ALL TRADES AND REMOVE ALL DEBRIS FROM THE CONSTRUCTION SITE. AT THE COMPLETION OF THE PROJECT, THE CONTRACTOR SHALL THOROUGHLY CLEAN THE BUILDING, SITE, AND ANY OTHER SURROUNDING AREAS TO A BETTER THAN EXISTING CONDITION.
- THE CONTRACTOR IS RESPONSIBLE FOR ADEQUATELY BRACING AND PROTECTING ALL WORK DURING CONSTRUCTION AGAINST DAMAGE, BREAKAGE, COLLAPSE, ETC. ACCORDING TO APPLICABLE CODES, STANDARDS, AND GOOD CONSTRUCTION PRACTICES.
- THE CONTRACTOR SHALL MEET ALL OSHA REQUIREMENTS FOR ALL INSTALLATIONS.
- THE CONTRACTOR SHALL BE RESPONSIBLE FOR ALL DAMAGES TO THE EXISTING CONSTRUCTION AND REPAIR ALL DAMAGES TO BETTER THAN PROPOSED CONSTRUCTION. THE CONTRACTOR SHALL NOTIFY AVISTA OF ANY DAMAGE TO THE SITE OR ANY ADJACENT STRUCTURES AROUND THE PROJECT. THE CONSULTANT SHALL BE SOLE AND FINAL JUDGE AS TO THE QUALITY OF THE REPAIRED CONSTRUCTION. ANY ADDITIONAL MODIFICATIONS WHICH MUST BE MADE SHALL BE MADE AT THE CONTRACTOR'S EXPENSE.
- WHERE ONE DETAIL IS SHOWN FOR ONE CONDITION, IT SHALL APPLY FOR ALL LIKE OR SIMILAR CONDITIONS, EVEN THOUGH NOT SPECIFICALLY MARKED ON THE DRAWINGS OR REFERRED TO IN THE SPECIFICATIONS, UNLESS NOTED OTHERWISE.
- WHERE PROPOSED PAVING, CONCRETE SIDEWALKS OR PATHS MEET EXISTING CONSTRUCTION, THE CONTRACTOR SHALL MATCH THE EXISTING PITCH, GRADE, AND ELEVATION SO THE ENTIRE STRUCTURE SHALL HAVE A SMOOTH TRANSITION.
- THE CONTRACTOR SHALL MODIFY THE EXISTING STRUCTURE AS REQUIRED. WHERE THE EXISTING STRUCTURE MUST BE MODIFIED, GENERAL CONTRACTOR SHALL REPAIR TO ORIGINAL CONDITION. ALL WORK SHALL BE COVERED UNDER THE GENERAL CONTRACT.

- VERIFY ALL EXISTING DIMENSIONS PRIOR TO PERFORMING WORK.
- VERIFY LOCATION OF ALL BURIED UTILITIES PRIOR TO ANY EXCAVATION.
- THE GENERAL CONTRACTOR SHALL BE RESPONSIBLE FOR APPLYING FOR COMMERCIAL POWER IMMEDIATELY UPON AWARD OF CONTRACT. THE GENERAL CONTRACTOR IS REQUIRED TO KEEP ALL DOCUMENTATION RECEIVED FROM THE POWER COMPANY, ACKNOWLEDGING APPLICATION FOR POWER, WRITTEN AND VERBAL DISCUSSIONS WITH THE POWER COMPANY, ETC.
- THE GENERAL CONTRACTOR SHALL OBTAIN WRITTEN CONFIRMATION OF THE EXPECTED DATE OF COMPLETION OF THE POWER CONNECTION FROM THE POWER COMPANY.
- IF THE POWER COMPANY IS UNABLE TO PROVIDE THE POWER CONNECTION BY OWNER'S REQUIRED DATE, THE GENERAL CONTRACTOR SHALL PROVIDE AND MAINTAIN A TEMPORARY GENERATOR UNTIL THE POWER COMPANY CONNECTION IS COMPLETED. COSTS ASSOCIATED WITH THE TEMPORARY GENERATOR TO BE APPROVED BY THE OWNER.
- IF THE GENERAL CONTRACTOR FAILS TO TAKE NECESSARY MEASURES AS DESCRIBED IN NOTES 19, 20 AND 21 ABOVE, THE GENERAL CONTRACTOR SHALL PROVIDE A TEMPORARY GENERATOR AT NO COST TO THE OWNER.
- PLANS PART OF THIS SET ARE COMPLEMENTARY. INFORMATION IS NOT LIMITED TO ONE PLAN. DRAWINGS AND SPECIFICATIONS ARE INSTRUMENTS OF SERVICE AND SHALL REMAIN THE PROPERTY OF THE ARCHITECT, WHETHER THE PROJECT FOR WHICH THEY ARE MADE IS EXECUTED OR NOT. THEY ARE NOT TO BE USED BY THE OWNER ON OTHER PROJECTS OR EXTENSION TO THIS PROJECT EXCEPT BY AGREEMENT IN WRITING AND WITH APPROPRIATE COMPENSATION TO THE ARCHITECT. THESE PLANS WERE PREPARED TO BE SUBMITTED TO GOVERNMENTAL BUILDING AUTHORITIES FOR REVIEW FOR COMPLIANCE WITH APPLICABLE CODES AND IT IS THE SOLE RESPONSIBILITY OF THE OWNER AND/OR CONTRACTOR TO BUILD ACCORDING TO APPLICABLE BUILDING CODES.
- IF CONTRACTOR OR SUB-CONTRACTOR FIND IT NECESSARY TO DEVIATE FROM ORIGINAL APPROVED PLANS, THEN IT IS THE CONTRACTOR'S AND THE SUB-CONTRACTOR'S RESPONSIBILITY TO PROVIDE THE ARCHITECT WITH 4 COPIES OF THE PROPOSED CHANGES FOR HIS APPROVAL BEFORE PROCEEDING WITH THE WORK. IN ADDITION THE CONTRACTOR AND SUB-CONTRACTORS SHALL BE RESPONSIBLE FOR PROCURING ALL NECESSARY APPROVALS FROM THE BUILDING AUTHORITIES FOR THE PROPOSED CHANGES BEFORE PROCEEDING WITH THE WORK. THE CONTRACTOR AND SUB-CONTRACTORS SHALL BE RESPONSIBLE FOR PROCURING ALL NECESSARY INSPECTIONS AND APPROVALS FROM BUILDING AUTHORITIES DURING THE EXECUTION OF THE WORK.
- IN EVERY EVENT, THESE CONSTRUCTION DOCUMENTS AND SPECIFICATIONS SHALL BE INTERPRETED TO BE A MINIMUM ACCEPTABLE MEANS OF CONSTRUCTION BUT THIS SHALL NOT RELIEVE THE CONTRACTOR, SUB-CONTRACTOR, AND/OR SUPPLIER/MANUFACTURER FROM PROVIDING A COMPLETE AND CORRECT JOB WHEN ADDITIONAL ITEMS ARE REQUIRED TO THE MINIMUM SPECIFICATION. IF ANY ITEMS NEED TO EXCEED THESE MINIMUM SPECIFICATIONS TO PROVIDE A COMPLETE, ADEQUATE AND SAFE WORKING CONDITION, THEN IT SHALL BE THE DEEMED AND UNDERSTOOD TO BE INCLUDED IN THE DRAWINGS. FOR EXAMPLE, IF AN ITEM AND/OR PIECE OF EQUIPMENT REQUIRES A LARGER WIRE SIZE (I.E. ELECTRICAL WIRE), STRONGER OR LARGER PIPING, INCREASED QUANTITY (I.E. STRUCTURAL ELEMENTS), REDUCED SPACING, AND/OR INCREASED LENGTH (I.E. BOLT LENGTHS, BAR LENGTHS) THEN IT SHALL BE DEEMED AND UNDERSTOOD TO BE INCLUDED IN THE BID/PROPOSAL. THESE DOCUMENTS ARE MEANT AS A GUIDE AND ALL ITEMS REASONABLY INFERRED SHALL BE DEEMED TO BE INCLUDED.
- THESE CONTRACT DOCUMENTS AND SPECIFICATIONS SHALL NOT BE CONSTRUED TO CREATE A CONTRACTUAL RELATIONSHIP OF ANY KIND BETWEEN THE ARCHITECT AND THE CONTRACTOR.

LINE/ANTENNA NOTES

- ALL THREADED STRUCTURAL FASTENERS FOR ANTENNA SUPPORT ASSEMBLES SHALL CONFORM TO ASTM A307 OR ASTM A36. ALL STRUCTURAL FASTENERS FOR STRUCTURAL STEEL FRAMING SHALL CONFORM TO ASTM A325. FASTENERS SHALL BE 5/8" MIN. DIA. BEARING TYPE CONNECTIONS WITH THREADS EXCLUDED FROM THE PLANE. ALL EXPOSED FASTENERS, NUTS, AND WASHERS SHALL BE GALVANIZED OTHERWISE NOTED. CONCRETE EXPANSION ANCHORS SHALL BE HILTI KWIK BOLTS UNLESS OTHERWISE NOTED. ALL ANCHORS INTO CONCRETE SHALL BE STAINLESS STEEL.
- NORTH ARROW SHOWN ON PLANS REFERS TO TRUE NORTH. CONTRACTOR SHALL VERIFY MAGNETIC NORTH AND NOTIFY CONSULTANT OF ANY DISCREPANCY BEFORE STARTING CONSTRUCTION.
- PROVIDE LOCK WASHERS FOR ALL MECHANICAL CONNECTIONS FOR GROUND CONDUCTORS. USE STAINLESS STEEL HARDWARE THROUGHOUT.
- THOROUGHLY REMOVE ALL PAINT AND CLEAN ALL DIRT FROM SURFACES REQUIRING GROUND CONNECTIONS.
- MAKE ALL GROUND CONNECTIONS AS SHORT AND DIRECT AS POSSIBLE. AVOID SHARP BENDS. ALL BENDS TO BE A MIN. OF 8" RADIUS.
- FOR GROUNDING TO GROUND BARS USE A TWO-BOLT HOLE NEMA DRILLED CONNECTOR SUCH AS T&B 32007 OR APPROVED EQUAL.
- FOR ALL EXTERNAL GROUND CONNECTIONS, CLAMPS AND CADWELDS, APPLY A LIBERAL PROTECTIVE COATING OR AN ANTI-OXIDE COMPOUND.
- REPAIR ALL GALVANIZED SURFACES THAT HAVE BEEN DAMAGED BY THERMO-WELDING. USE ERICO T-319 GALVANIZING BAR/COLD GALVANIZING PAINT.

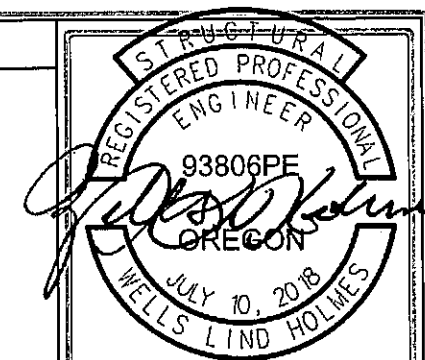

EXPIRES: 6/30/2025
02/11/2025
VSE Project Number: U2350-1241-241

NO.	DATE	DRAWN	REVISION
A	05/22/23	KM	90% PCD REVIEW
B	08/03/23	KM	SURVEY UPDATE
C	08/04/24	KM	RFDS UPDATE
0	12/11/24	DO	100% FINAL CD
1	01/27/25	KM	CLIENT COMMENTS
2	02/11/25	KM	CLIENT COMMENTS



PROJECT INFORMATION

- THIS IS AN UNMANNED FACILITY AND RESTRICTED ACCESS EQUIPMENT AND WILL BE USED FOR THE TRANSMISSION OF RADIO SIGNALS FOR THE PURPOSE OF PROVIDING PUBLIC CELLULAR SERVICE.
- VERIZON WIRELESS CERTIFIES THAT THIS TELEPHONE EQUIPMENT FACILITY WILL BE SERVICED ONLY BY VERIZON WIRELESS EMPLOYEE SERVICE PERSONNEL FOR REPAIR PURPOSES ONLY. THIS FACILITY IS UNOCCUPIED AND NOT DESIGNED FOR HUMAN OCCUPANCY THUS IT IS NOT OPEN TO THE PUBLIC.
- THIS FACILITY WILL CONSUME NO UNRECOVERABLE ENERGY.
- NO POTABLE WATER SUPPLY IS TO BE PROVIDED AT THIS LOCATION.
- NO WASTE WATER WILL BE GENERATED AT THIS LOCATION.
- NO SOLID WASTE WILL BE GENERATED AT THIS LOCATION.
- VERIZON WIRELESS MAINTENANCE CREW (TYPICALLY ONE PERSON) WILL MAKE AN AVERAGE OF ONE TRIP PER MONTH AT ONE HOUR PER VISIT.

LEGEND

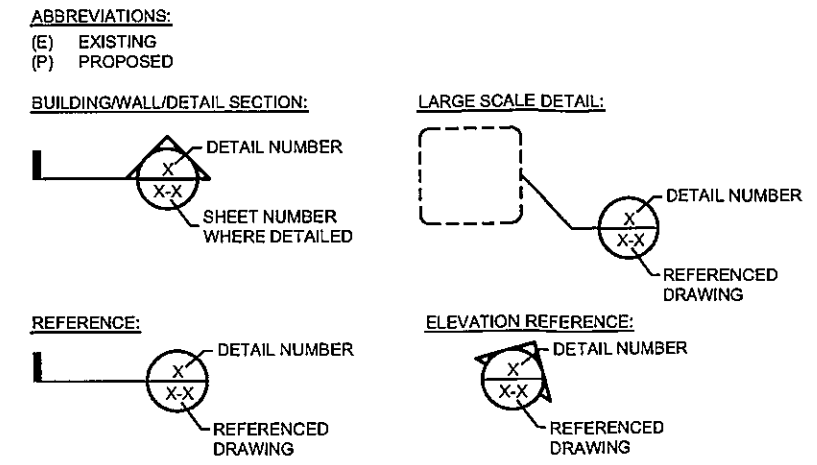

IMPORTANT NOTICE

THE EXISTING CONDITIONS REPRESENTED HEREIN ARE BASED ON VISUAL OBSERVATIONS AND INFORMATION PROVIDED BY OTHERS. ACOM CONSULTING CANNOT GUARANTEE THE CORRECTNESS NOR COMPLETENESS OF THE EXISTING CONDITIONS SHOWN AND ASSUMES NO RESPONSIBILITY THEREOF. CONTRACTOR AND HIS SUB-CONTRACTORS SHALL VISIT THE SITE AND VERIFY ALL EXISTING CONDITIONS AS REQUIRED FOR PROPER EXECUTION OF PROJECT. REPORT ANY CONFLICTS OR DISCREPANCIES TO THE CONSULTANT PRIOR TO CONSTRUCTION.

**HWY 6
SMALL CELL NODE 07**
35300 WILSON RIVER HWY
TILLAMOOK, OR 97141

GENERAL NOTES
AND SYMBOLS

T-2

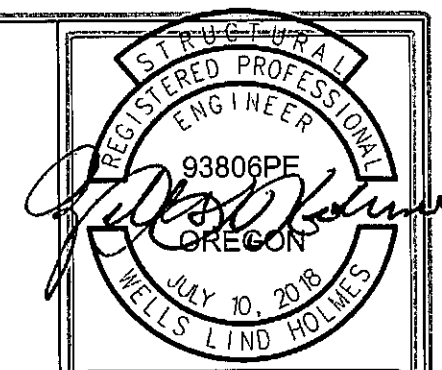

EXPIRES: 6/30/2025
 02/11/2025
 VSE Project Number: U2350-1241-241

NO.	DATE	DRAWN	REVISION
A	05/22/23	KM	90% PCD REVIEW
B	08/03/23	KM	SURVEY UPDATE
C	08/04/24	KM	RFDS UPDATE
0	12/11/24	DO	100% FINAL CD
1	01/27/25	KM	CLIENT COMMENTS
2	02/11/25	KM	CLIENT COMMENTS

CLIENT:
verizon

A&E CONSULTANT, SITE ACQUISITION AND PERMITTING
Acom
 CONSULTING, INC

VECTOR
 ENGINEERS



**HWY 6
 SMALL CELL NODE 07**
 35300 WILSON RIVER HWY
 TILLAMOOK, OR 97141

**OVERALL SITE
 PLAN**

A-1.0

TAX LOT
 #1N0825000500

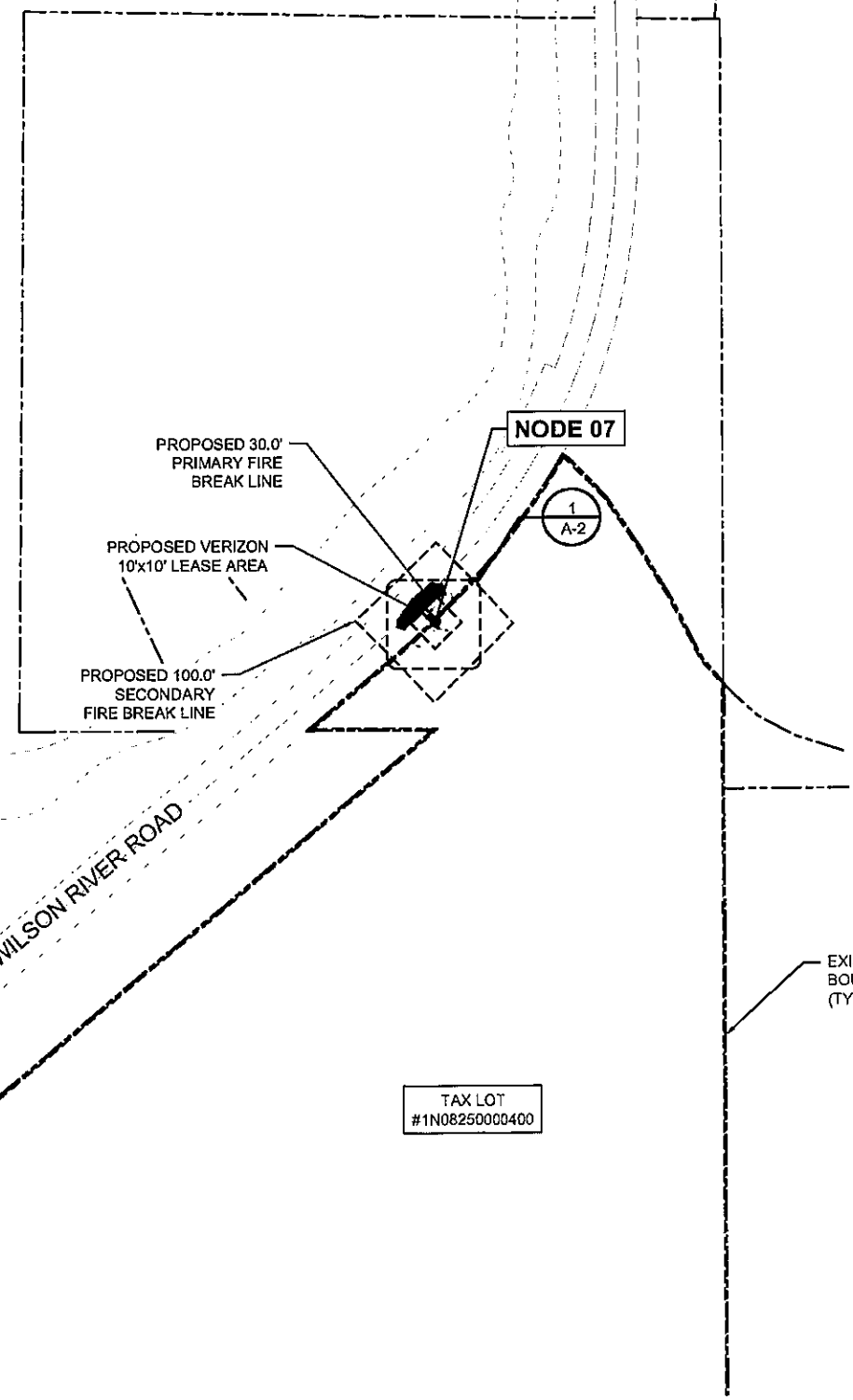

TAX LOT
 #1N070003700

TAX LOT
 #1N0825000400

EXISTING PARCEL
 BOUNDARY LINE
 (TYP)



22"x34" SCALE: 1" = 100'-0"
 11"x17" SCALE: 1" = 200'-0"
 100' 50' 0' 100'

POLE MOUNTED EQUIPMENT SCHEDULE									
CATEGORY	MANUFACTURER	MODEL NUMBER	UNIT HEIGHT / LENGTH	UNIT WIDTH	UNIT DEPTH	UNIT WEIGHT	MOUNT HEIGHT (CENTER)	PROPOSED	
								QUANTITY	WEIGHT
MOUNT	SITEPRO1	CWT01	--	--	--	116.50 LBS	33'-0"	3	349.5 LBS
MOUNT	SITEPRO1	UGLM	--	--	--	87.58 LBS	33'-0"	1	87.58 LBS
ANTENNA	COMMSCOPE	NHH-45A-R2B	48.0"	18.0"	7.0"	63.1 LBS	33'-0"	2	66.0 LBS
RRU	ERICSSON	4890	21.8"	15.7"	7.5"	84.0 LBS	33'-0"	1	75.0 LBS
RRU	ERICSSON	4490	15.0"	13.0"	9.0"	70.0 LBS	33'-0"	1	71.0 LBS

PROPOSED ANTENNA CONFIGURATION AND CABLE SCHEDULE										
SECTOR	QTY	AZIMUTH	TECH.	TIP HEIGHT	MFR	MODEL #	ANTENNA SIZE	MECH. TILT	FEEDER CABLE	CABLE LGTH.
D1	1	0°	5G	79'-2" (79.2')	ERICSSON	AIR6419	34.5"	0° (2° ELEC)	FIBER	TBD
D2	1	0°	4G	80'-6" (80.5')	JMA	MX12FRO445-01	56.9"	0° (2° ELEC)	FIBER	TBD
D2	1	225°		79'-2" (79.2')	ERICSSON	AIR6419	34.5"	0° (2° ELEC)	FIBER	TBD
D2	1	225°		80'-6" (80.5')	JMA	MX12FRO445-01	56.9"	0° (2° ELEC)	FIBER	TBD

STRUCTURAL REGISTERED PROFESSIONAL ENGINEER
 93806PE
Wells Lind Holmes
 OREGON
 JULY 10, 2018
 WELLS LIND HOLMES
EXPIRES: 6/30/2025
 02/11/2025
 VSE Project Number: U2350-1241-241

ANTENNA SCHEDULE 2

NO.	DATE	DRAWN	REVISION
A	05/22/23	KM	90% PGD REVIEW
B	08/03/23	KM	SURVEY UPDATE
C	08/04/24	KM	RFDS UPDATE
0	12/11/24	DO	100% FINAL CD
1	01/27/25	KM	CLIENT COMMENTS
2	02/11/25	KM	CLIENT COMMENTS

CLIENT:

ARE CONSULTANT, SITE ACQUISITION AND PERMITTING:

HWY 6 SMALL CELL NODE 07
 35300 WILSON RIVER HWY
 TILLAMOOK, OR 97141

ANTENNA & EQUIPMENT PLANS

A-2.0

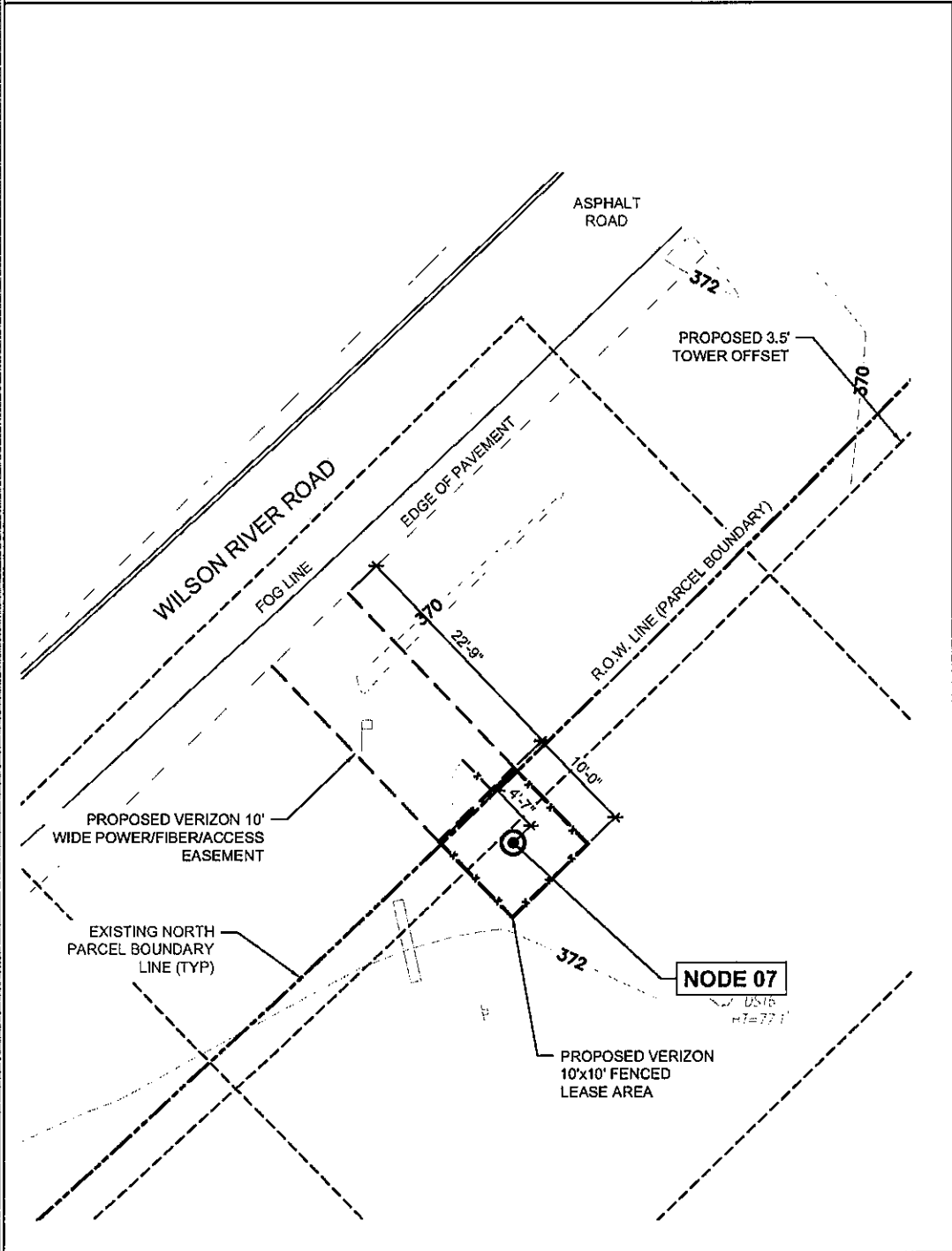

NOTE:
 ANTENNA/ANCILLARY EQUIPMENT MOUNT DESIGN/ANALYSIS TO BE PERFORMED BY OTHERS

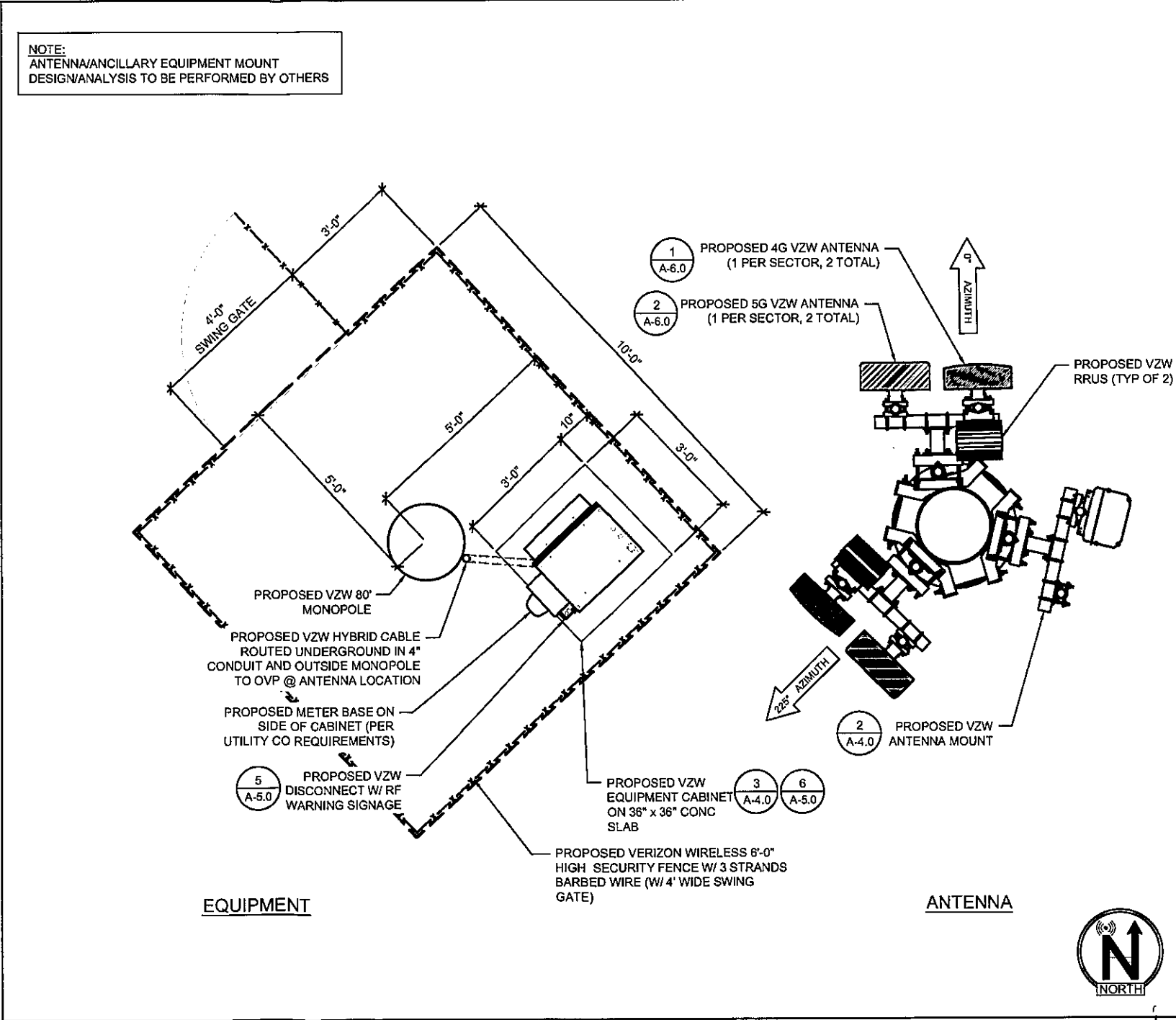

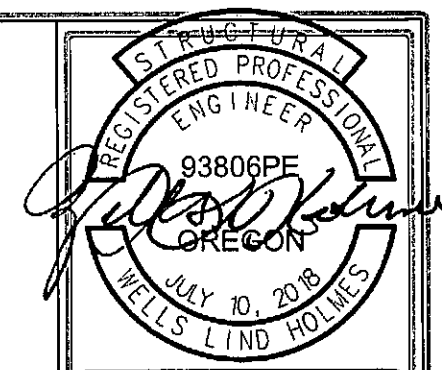
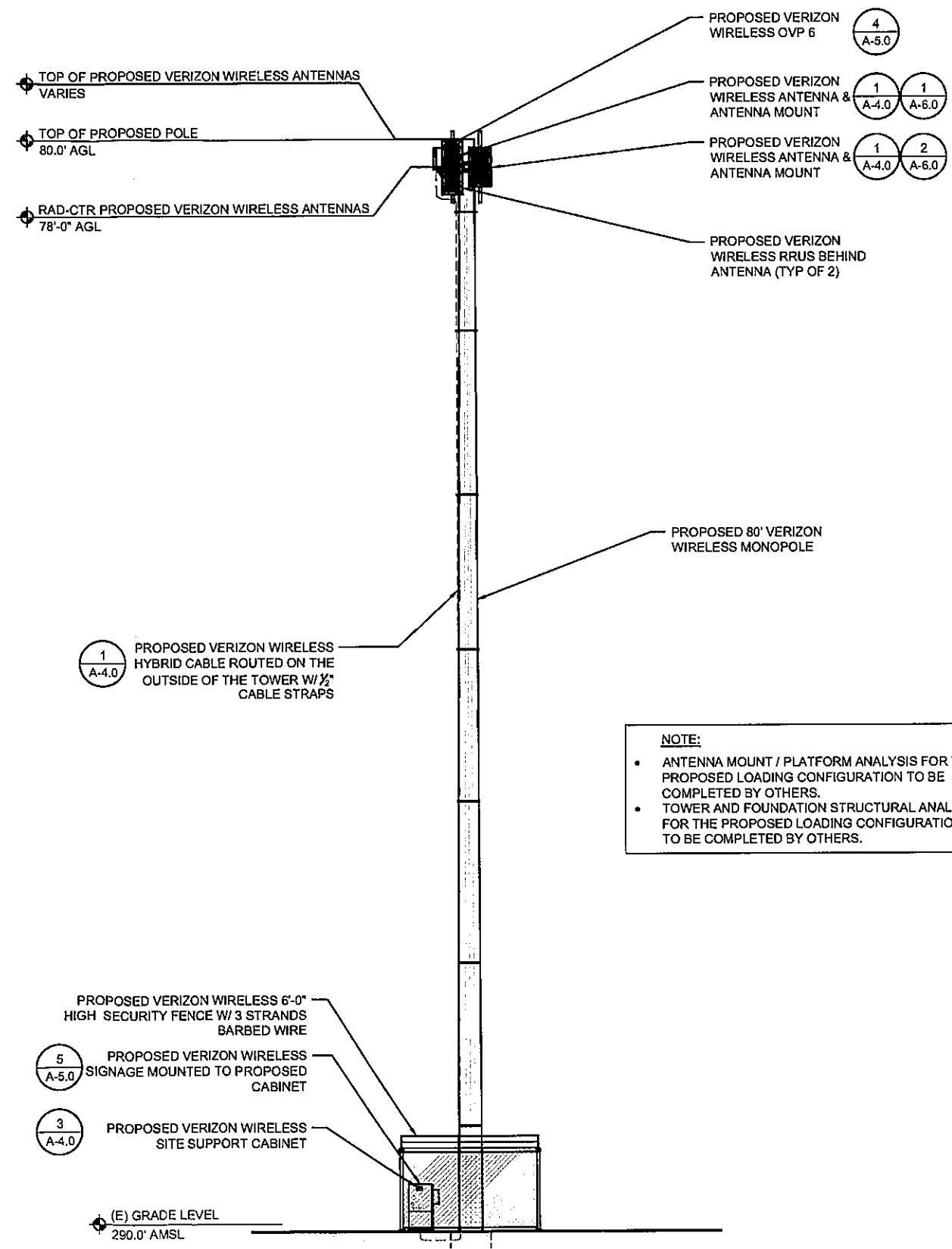

EXPIRES: 6/30/2025
 02/11/2025
 VSE Project Number: U2350-1241-241

NO.	DATE	DRAWN	REVISION
A	05/22/23	KM	90% PCD REVIEW
B	08/03/23	KM	SURVEY UPDATE
C	08/04/24	KM	RFDS UPDATE
D	12/11/24	DO	100% FINAL CD
1	01/27/25	KM	CLIENT COMMENTS
2	02/11/25	KM	CLIENT COMMENTS



NOTE:

- ANTENNA MOUNT / PLATFORM ANALYSIS FOR THE PROPOSED LOADING CONFIGURATION TO BE COMPLETED BY OTHERS.
- TOWER AND FOUNDATION STRUCTURAL ANALYSIS FOR THE PROPOSED LOADING CONFIGURATION TO BE COMPLETED BY OTHERS.

**HWY 6
 SMALL CELL NODE 07**
 35300 WILSON RIVER HWY
 TILLAMOOK, OR 97141

EXISTING & PROPOSED
 ELEVATIONS

A-3.0

22"x34" SCALE: 3/8" = 1'-0"
 11"x17" SCALE: 3/16" = 1'-0"

EXISTING ELEVATION 1

22"x34" SCALE: 3/16" = 1'-0"
 11"x17" SCALE: 3/32" = 1'-0"

PROPOSED ELEVATION 2

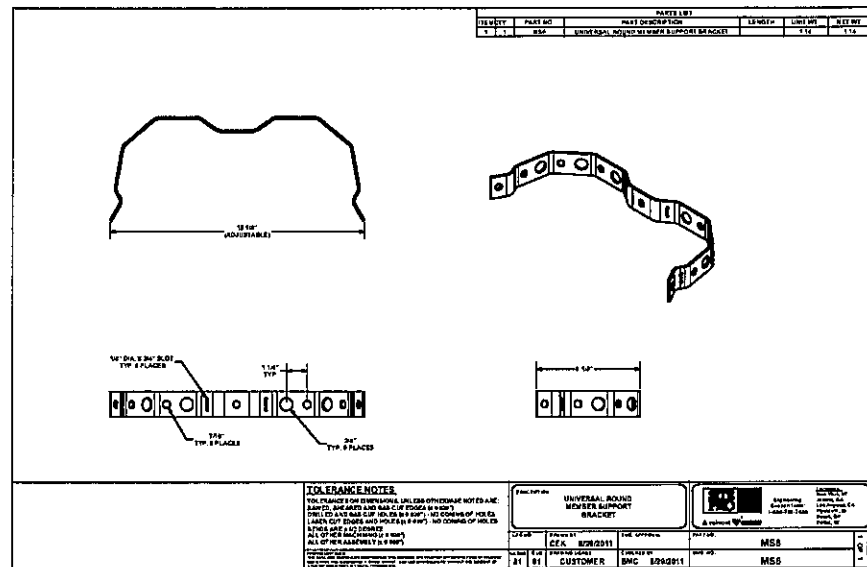

- NOTE:**
- ATTACH TO MONOPOLE WITH 1/2" BANDING PER MANUFACTURER'S RECOMMENDATIONS
 - PROVIDE SNAP-IN HANGERS TO SUPPORT THE HYBRID CABLE(S)

TOWER - HYBRID SUPPORT BRACKET 1

22"x34" SCALE: NOT TO SCALE
11"x17" SCALE: NOT TO SCALE

Charles Universal Broadband Enclosures (CUBE) RL212 Series Remote Radio Head / Power Support Cabinets

The CUBE-RL212 Series cabinet provides environmental protection for a wide variety of telecom applications, including wireless, fiber transport for cell site backhaul, and other remote outdoor applications where 48 VDC is required. The most common applications for these cabinets are to house power and battery backup for remote radio heads. Commercial AC power is converted to 48 VDC using a third-party rectifier (supports most major manufacturers). The separate battery chamber is designed for up to 100Ah Ni-Cd or VRLA batteries.

Specifications:

- Overall Dimensions: 33"H x 26"W x 20"D
- Equipment Chamber: 24"H x 26"W x 20"D
- Rack Space / Width: 12RU / 19" EIA Standard
- Door Lock: Padlockable, 2-18" Style Lock
- AC Equipment: 8 Position Load Center
- Battery Chamber: 15"H x 26"W x 20"D
- Capacity: Supports 1 String 48V (or two 24V) 100Ah Ni-Cd or VRLA
- Bonding & Grounding: 8 Position, 2-Hole Ground Bar
- Cable Entrances: (3) 1.75"/2.5" Knockouts on Right-Hand Side, (1) 1.75"/2.5" and (2) 1.375" Knockouts on Bottom
- Thermal Management: 24VDC/48VDC 500 or 750 Watt Heat Exchangers
- Construction: 1/8" Welded Aluminum, Off-White Finish
- Mounting: Wall or H-Frame, Pole Mount Kit optional (97-CABPMTKIT), 10" Flair optional (97-002176-A)

MADE IN THE USA

Charles Part #	Standard Mounting	Overall Dimensions (in.)	RU	Equipment Chamber Dimensions (in.)	Battery Chamber Dimensions (in.)	Load Center	Thermal	Integrated Power	Weight Empty (lbs.)	Weight with Cd Battery
CUBE-RL2121AB1	Wall/H-Frame	39x26x20	12	24x26x20	15x26x20	8 Position	500W 48VDC HX	GE SPS 48V (2) 20A Rectifiers	170	372
CUBE-RL21221AE2	Wall/H-Frame	39x26x20	12	24x26x20	15x26x20	6 Pos & Gen	500W 48VDC HX	GE SPS 48V (2) 20A Rectifiers	170	372
CUBE-RL21221AH1	Wall/H-Frame	39x26x20	12	24x26x20	15x26x20	8 Position	500W 48VDC HX	Etek 48V (2) 40A Rectifiers	165	367
CUBE-RL21221AH3	Wall/H-Frame	39x26x20	12	24x26x20	15x26x20	8 Position	500W 24VDC HX	Etek 24V (2) 80A Rectifiers	165	367
CUBE-RL21221AH4	Wall/H-Frame	39x26x20	12	24x26x20	15x26x20	8 Position	500W 48VDC HX	Etek 48V (1) 40A Rectifier	165	367
CUBE-RL21221AH5	Wall/H-Frame	39x26x20	12	24x26x20	15x26x20	8 Position	500W 48VDC HX	None	160	352
CUBE-RL21221AH7	Wall/H-Frame	39x26x20	12	24x26x20	15x26x20	8 Position	500W 24VDC HX	Etek 24V (2) 40A Rectifiers	165	367
CUBE-RL21221AH8	Wall/H-Frame	39x26x20	12	24x26x20	15x26x20	8 Position	500W 48VDC HX	GE Infinity D 48V, No Rectifiers	160	355
CUBE-RL21221DB1	Wall/H-Frame	39x26x20	12	24x26x20	15x26x20	8 Position	750W 48VDC HX	None	160	352
CUBE-RL21221DB2	Wall/H-Frame	39x26x20	12	24x26x20	15x26x20	8 Position	750W 48VDC HX	GE Infinity D 48V, (2) 50A Rectifiers	165	367
CUBE-RL21221DL1	Wall/H-Frame	39x26x20	12	24x26x20	15x26x20	8 Pos & Gen	750W 48VDC HX	None	150	355
CUBE-RL21221DL2	Wall/H-Frame	39x26x20	12	24x26x20	15x26x20	8 Pos & Gen	750W 48VDC HX	GE Infinity D 48V	180	385

For additional product information, please visit www.charlesindustries.com CG 059030-118

INNOVATIVE ENCLOSED SOLUTIONS

EQUIPMENT CABINET SPECIFICATIONS 3

Ordering Information – Infinity D Power System

Dual Voltage, Modular Power System

Infinity-D may be configured as a +24V or -48V single voltage power system or as a 'dual voltage' power system that supports rectifiers and converters. The primary voltage is supported by +24V or -48V rectifiers and battery reserve, while secondary voltage is supported by DC/DC converters. The primary voltage capacity is 1,600A at both 24V and 48V. Secondary voltage capacity is up to 300A per system expansion module.

- Features**
- Infinity Rectifiers for +24V and -48V applications.
 - Modular architecture for easy growth and low cost
 - DC/DC converter support for dual voltage systems
 - DC distribution in each system module for efficient scalability
 - Temperature hardened harsh environments, (-40°C to +75°C)
 - Compact size: 8" (203mm) high, 16.9" (429mm) deep
 - Adjustable frame mounting for 19", 23" and 26" applications
 - Battery panel for battery connection and LVBD option
 - Plug-N-Play Pulsar Plus controller with Web based interface for local and remote (CD-LAN) access.
 - Distribution options include 3A-400A bullet style circuit breakers and GMT fuses

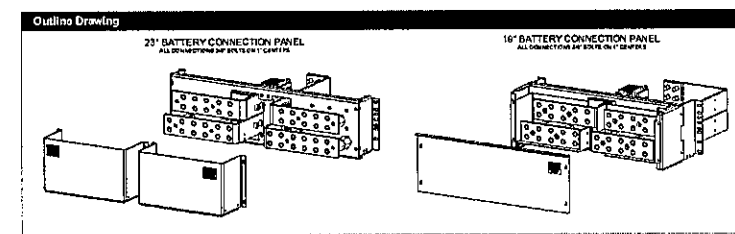
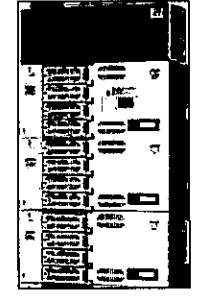

Output	Ordering Code	Model	Frame	Picture
200A	CC109151107	H2007001 G203, G211D, G223	No Frame	
	CC109150103	H2007001 G203, G221F, G223	System width 23"	
			System width 19"	

GE INFINITY D 48V PDU SPECIFICATIONS 4

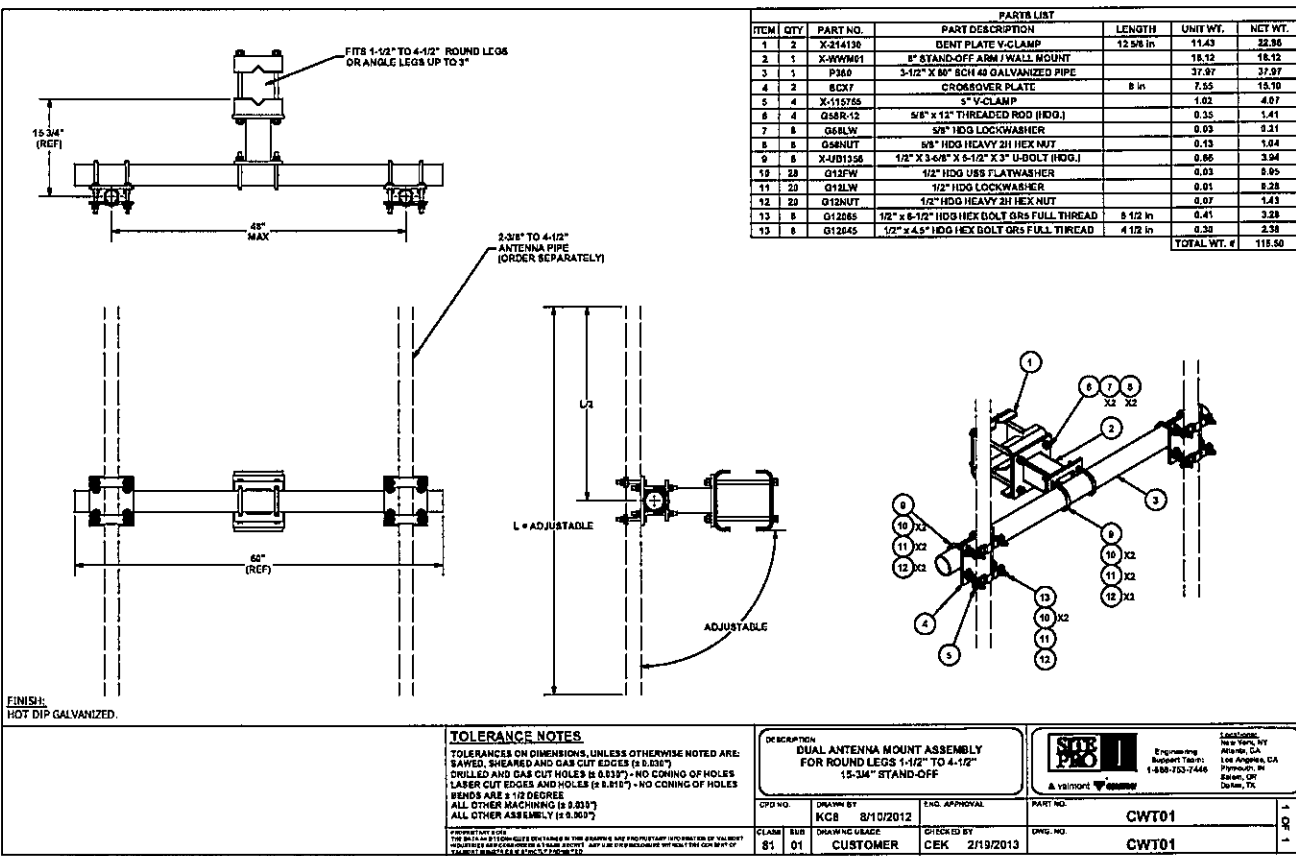

ANTENNA MOUNT DETAIL 2

22"x34" SCALE: NOT TO SCALE
11"x17" SCALE: NOT TO SCALE



EXPIRES: 6/30/2025
02/11/2025
VSE Project Number: U2350-1241-241

NO.	DATE	DRAWN	REVISION
A	05/22/23	KM	90% PCD REVIEW
B	08/03/23	KM	SURVEY UPDATE
C	08/04/24	KM	RFDS UPDATE
D	12/11/24	DO	100% FINAL CD
1	01/27/25	KM	CLIENT COMMENTS
2	02/11/25	KM	CLIENT COMMENTS



**HWY 6
SMALL CELL NODE 07**
35300 WILSON RIVER HWY
TILLAMOOK, OR 97141

**CONSTRUCTION
DETAILS**

A-4.0

MANUFACTURER: ERICSSON
 MODEL: RADIO 4890
 HEIGHT: 21.80"
 WIDTH: 15.70"
 DEPTH: 7.50"
 WEIGHT: 84 LBS
 COLOR: OFF-WHITE

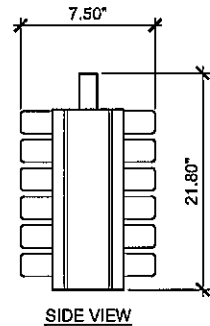
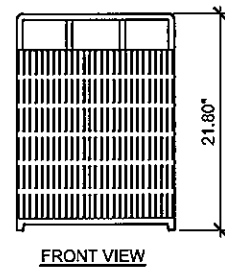
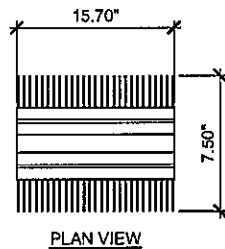

MANUFACTURER: ERICSSON
 MODEL: RADIO 4490
 HEIGHT: 15.00"
 WIDTH: 13.00"
 DEPTH: 9.00"
 WEIGHT: 70 LBS
 COLOR: OFF-WHITE

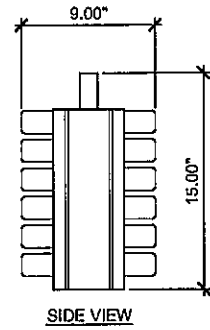
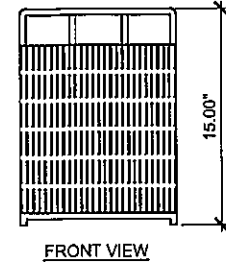
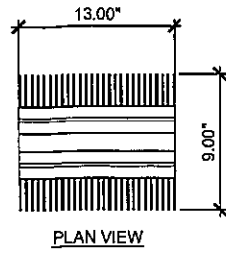

22"x34" SCALE: NOT TO SCALE
 11"x17" SCALE: NOT TO SCALE
 4890 RADIO 1

22"x34" SCALE: NOT TO SCALE
 11"x17" SCALE: NOT TO SCALE
 4490 RADIO 2

22"x34" SCALE: NOT TO SCALE
 11"x17" SCALE: NOT TO SCALE
 NOT USED 3

MANUFACTURER: RAYCAP
 MODEL: RCMDC-3315-PF-48
 HEIGHT: 29.93"
 WIDTH: 15.73"
 DEPTH: 10.30"
 WEIGHT: 32.00 LBS (W/ MOUNT)
 COLOR: LIGHT GRAY

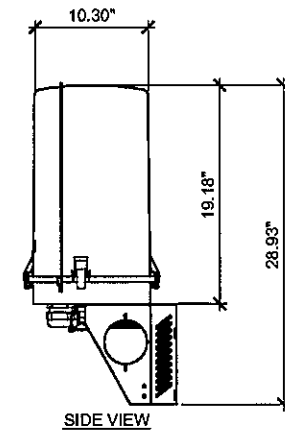
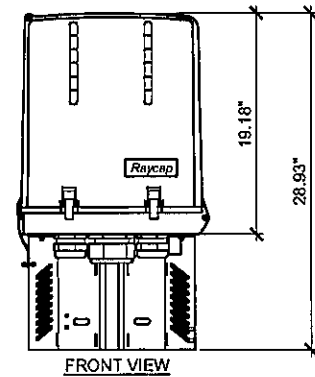
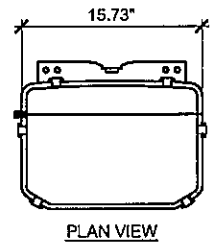

THE CONTRACTOR WILL ENSURE ALL SIGNAGE AT SITE LOCATION TO MEET WITH FCC STANDARDS AND REQUIREMENTS.

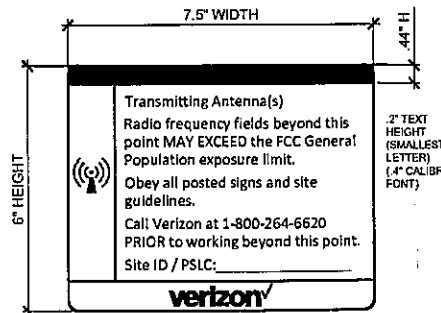

RF NOTICE SIGN
 NOT TO SCALE

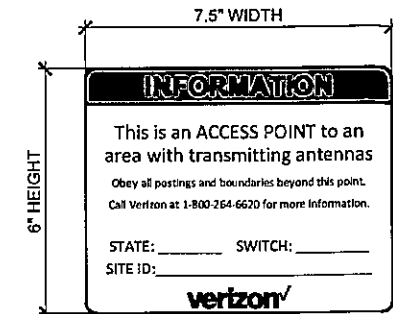

RF INFORMATION SIGN
 NOT TO SCALE

22"x34" SCALE: NOT TO SCALE
 11"x17" SCALE: NOT TO SCALE
 RAYCAP OVP 6 4

22"x34" SCALE: NOT TO SCALE
 11"x17" SCALE: NOT TO SCALE
 RF SIGNAGE DETAILS 5

FINAL DESIGN AND ANALYSIS OF CONCRETE FOOTING AND ANCHORAGE TO BE COMPLETED BY OTHERS

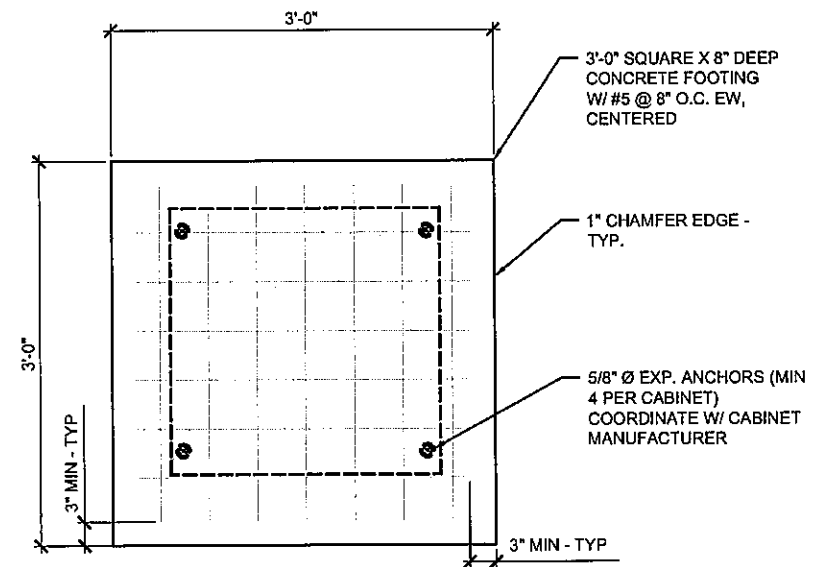

CONCRETE PAD DETAIL 6

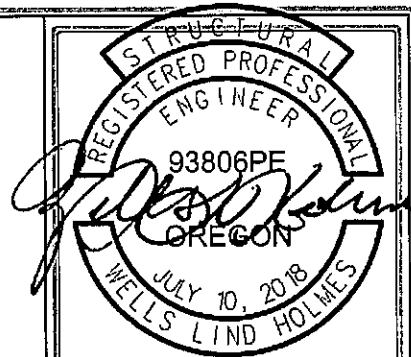

EXPIRES: 6/30/2025
 02/11/2025
 VSE Project Number: U2350-1241-241

NO.	DATE	DRAWN	REVISION
A	05/22/23	KM	90% PGD REVIEW
B	08/03/23	KM	SURVEY UPDATE
C	06/04/24	KM	RFDS UPDATE
0	12/11/24	DO	100% FINAL CD
1	01/27/25	KM	CLIENT COMMENTS
2	02/11/25	KM	CLIENT COMMENTS

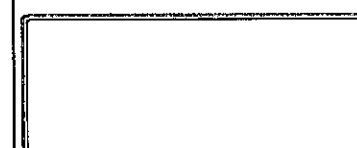

**HWY 6
 SMALL CELL NODE 07**
 35300 WILSON RIVER HWY
 TILLAMOOK, OR 97141

**CONSTRUCTION
 DETAILS**

A-5.0

TECHNICAL SPECIFICATIONS AIR 6419 B41

PRODUCT NUMBER:	KRD 901 212/11		
ADVANCED ANTENNA SYSTEM			
Operating frequency band:	3GPP Band 41, 2496 – 2690 MHz (full band)		
Instantaneous bandwidth:	194 MHz		
Output Power	320 W		
EIRP max.	79 dBm		
Antenna configuration	(3x1) x (4x8)		
Architecture:	64T64R connected to an array of dual polarized antenna elements.		
Modulation:	Downlink	Up to 256 QAM.	
	Uplink	Up to 64 QAM.	
Multi-antenna beamforming functionality*:	Downlink SU-MIMO		
	Downlink MU-MIMO	Up to 16 layers per carrier.	
	Uplink SU-MIMO		
	Uplink MU-MIMO	Up to 16 layers per carrier.	
	Cell shaping	Pre-defined cell or broadcast beam shapes ¹ : Macro, Hotspot and High-rise.	
	Digital down-tilt	Continuously adjustable for macro scenario, fixed for Hotspot and High-rise scenario.	
Mechanical specifications*			
Weight:	31 kg (68.5 lbs) excluding installation kit		
Size (H x W x D):	876 x 596 x 203 mm (34.5" x 28.8" x 8.0") (including protrusions)		
	852 x 596 x 160 mm (33.6" x 28.8" x 6.3") (excluding protrusions)		
Operational specifications*			
Wind Load Maximum:	653 N (front), 110 N (side) @ 42 m/s wind speed (pole installed)		
Operating Temperature Range:	-40° to +55° C		
Solar radiation:	≤ 1,120 W/m ²		
Relative humidity:	2% to 100%		
Absolute humidity:	0.26 to 40 g/m ³		
IP Classification:	IP65		
Main Interfaces			
Baseband:	Two eCPRI interfaces using 25G SFP+ ports with link capacity 25 Gb/s each. One 25 Gb/s eCPRI interface is sufficient for up to 100 MHz carrier bandwidth and 16 layers.		
Power Supply:	-48 V DC (3-wire or 2-wire) via a connector. Maximum fuse rating is 50 A.		
Mounting:	Optional mechanical tilt and swivel installation kit for wall and pole mounting.		
Handling:	Handle for lifting and hoisting.		

* Additional scenarios, cells or broadcast beam shapes possible with future software releases. Refer detailed description for more details on NR and ETRP for specific scenarios.

Final
Telefoniska tekniska LM Ericsson
SE-164 00 Stockholm, Sweden
www.ericsson.com

© Ericsson 2022



MX12FRO445-01

NWAV™ X-Pol 12-Port Antenna

X-Pol 12-Port 4 ft, 45° Fast Roll Off, with Smart Bias Ts, 698-2690 MHz:

4 ports 698-894 MHz, 8 ports 1695-2690 MHz

- 12-Port antenna offering the same functionality as 2 Hex Port antennas in a single unit
- Fast Roll Off (FRO™) Azimuth beam patterns improves intra-inter-cell SINR
- Optimized form factor for reduced wind loading
- Fully integrated (iRETs) with independent RET control for low band and mid band
- Excellent passive intermodulation (PIM) performance reduces harmful interference.
- Suitable for 3G, 4G, and 5G interface technologies
- Integrated Smart Bias-Ts reduce leasing costs



NWAV

Fast Roll-Off antennas increase data throughput without compromising coverage

The horizontal beam produced by Fast Roll-Off (FRO) technology increases the Signal to Interference & Noise Ratio (SINR) by eliminating overlap between sectors.

Non-FRO antenna Large traditional antenna pattern overlap creates harmful interference. **JMA FRO antenna** JMA's FRO antenna pattern minimizes overlap, thereby minimizing interference.

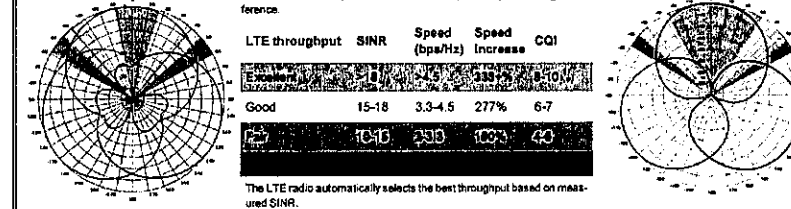

The LTE radio automatically selects the best throughput based on measured SINR.

Electrical specification (minimum/maximum)	Ports 1, 2, 3, 4				Ports 5, 6, 7, 8, 9, 10, 11, 12			
	698-806	806-894	1695-1880	1850-1990	1920-2180	2300-2360	2496-2690	
Frequency bands, MHz								
Polarization	± 45°				± 45°			
Average gain over all tilts, dBi	12.7	13.0	15.9	16.2	16.8	16.8	16.6	
Horizontal beamwidth (HBW), degrees ¹	45	43	40	40	36	31	29	
Front-to-back ratio, co-polar power @180°± 30°, dB	>25.0	>25.0	>25.0	>25.0	>25.0	>25.0	>25.0	
X-Pol discrimination (CPR) at boresight, dB	>20.0	>18.0	>19	>18	>18	>18	>18	
Vertical beamwidth (VBW), degrees ¹	31.0	27.0	12.0	11.4	11.0	10.0	9.0	
Electrical downtilt (EDT) range, degrees	2-16				0-9			
First upper side lobe (USLS) suppression, dB ¹	≤-18.0	≤-18.0	≤-18.0	≤-18.0	≤-18.0	≤-18.0	≤-18.0	
Cross-polar isolation, port-to-port, dB ¹	25	25	25	25	25	25	25	
Max VSWR / return loss, dB	1.5:1 / -14.0				1.5:1 / -14.0			
Max passive intermodulation (PIM), 2x20W carrier, dBc	-153				-153			
Max input power per any port, watts	300				250			
Total composite power all ports, watts					1500			

¹ Typical value over frequency and tilt

©2024 JMA Wireless. All rights reserved. This document contains proprietary information. All products, company names, brands, and logos are trademarks™ or registered® trademarks of their respective holders. All specifications are subject to change without notice. +1 315.431.7100 customerservice@jmawireless.com

01/02/24 V2.0

Page1

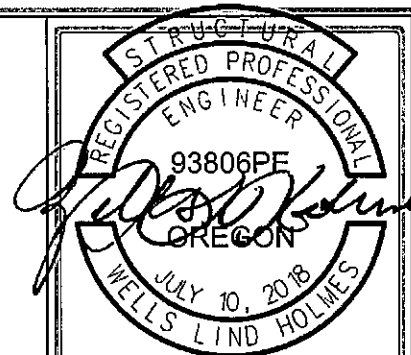

EXPIRES: 6/30/2025

02/11/2025

VSE Project Number: U2350-1241-241

NO.	DATE	DRAWN	REVISION
A	05/22/23	KM	90% PCD REVIEW
B	08/03/23	KM	SURVEY UPDATE
C	09/04/24	KM	RFDS UPDATE
D	12/11/24	DO	100% FINAL CD
1	01/27/25	KM	CLIENT COMMENTS
2	02/11/25	KM	CLIENT COMMENTS

CLIENT:



A/E CONSULTANT, SITE ACQUISITION AND PERMITTING:



**HWY 6
SMALL CELL NODE 07**
35300 WILSON RIVER HWY
TILLAMOOK, OR 97141

ANTENNA DETAILS

A-6.0

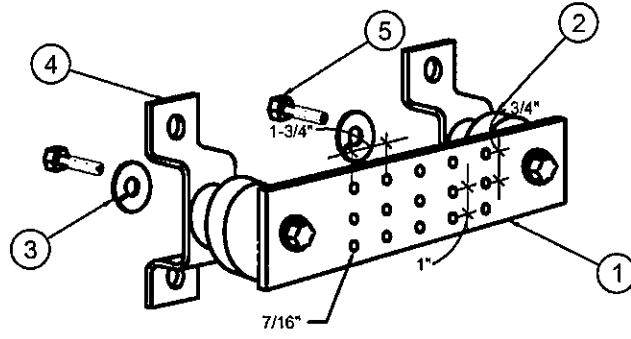

1. GALVANIZED STEEL GROUND BUSBAR, 1/4" X 4" X 6".
2. INSULATORS, MEET REQUIREMENTS OF UL 94 VO FOR SELF-EXTINGUISHING MATERIALS.
3. 3/8" LOCKWASHERS.
4. MOUNTING BRACKET.
5. 3/8-11 X 1" HHCS BOLTS.

22"x34" SCALE: NOT TO SCALE
11"x17" SCALE: NOT TO SCALE
GROUND BAR DETAIL 1

1. GROUNDING SHALL COMPLY WITH THE APPLICABLE EDITION OF THE NATIONAL ELECTRICAL CODE AS RECOGNIZED BY THE JURISDICTION.
2. ALL GROUNDING METHODS SHALL CONFORM TO THE CURRENT VERIZON STANDARDS.
3. MASTER GROUND BARS (MGB) SHALL BE GALVANIZED STEEL, 4" X 6" MAX.
4. MINIMUM BENDING RADIUS FOR GROUND CONDUCTOR IS 8", WHEN BENDING IS NECESSARY. GROUND CONDUCTORS ARE TO BE AS STRAIGHT AS POSSIBLE.
5. NO SPLICES PERMITTED IN GROUND CONDUCTORS.
6. ALL GROUNDING CONNECTORS TO BE CLEAN AND FREE OF PAINT AT THEIR MATING SURFACES AND INSTALLED PER MANUFACTURER'S RECOMMENDATIONS. USE PENETROX OR EQUIVALENT ANTIOXIDANT GREASE.
7. ALL GROUND BAR CONNECTIONS ARE TO BE 2 HOLE LUG COMPRESSION TYPE. STACKED CONNECTIONS ARE NOT ACCEPTABLE. BACK TO BACK CONNECTIONS ON OPPOSITE SIDES OF THE GROUND BAR WILL BE PERMITTED.
8. ENSURE ALL MECHANICAL CONNECTORS ARE TORQUED TO THE MANUFACTURER'S SPECIFIED VALUES.
9. IF EXISTING GROUND ROD IS NOT PRESENT, NEW GROUND ROD SHALL MEET AVISTA STANDARDS.
10. MULTIPLE BONDS ON GROUND RODS TO BE SEPARATED BY AT LEAST 6".
11. MAXIMUM RESISTANCE OF THE COMPLETED GROUND SYSTEM SHALL NOT EXCEED A RESISTANCE OF 5 OHMS TO EARTH.
12. GROUND WIRES SHALL NOT BE INSTALLED THROUGH HOLES IN ANY METAL OBJECTS OR SUPPORTS TO PRECLUDE ESTABLISHING A "CHOKE" POINT.
13. FERROUS METAL CLIPS WHICH COMPLETELY SURROUND THE GROUND WIRE SHALL NOT BE USED. METAL CLIPS THAT DO NOT COMPLETELY SURROUND THE GROUND WIRE OR PLASTIC ARE ACCEPTABLE.

22"x34" SCALE: NOT TO SCALE
11"x17" SCALE: NOT TO SCALE
GROUNDING NOTES 2

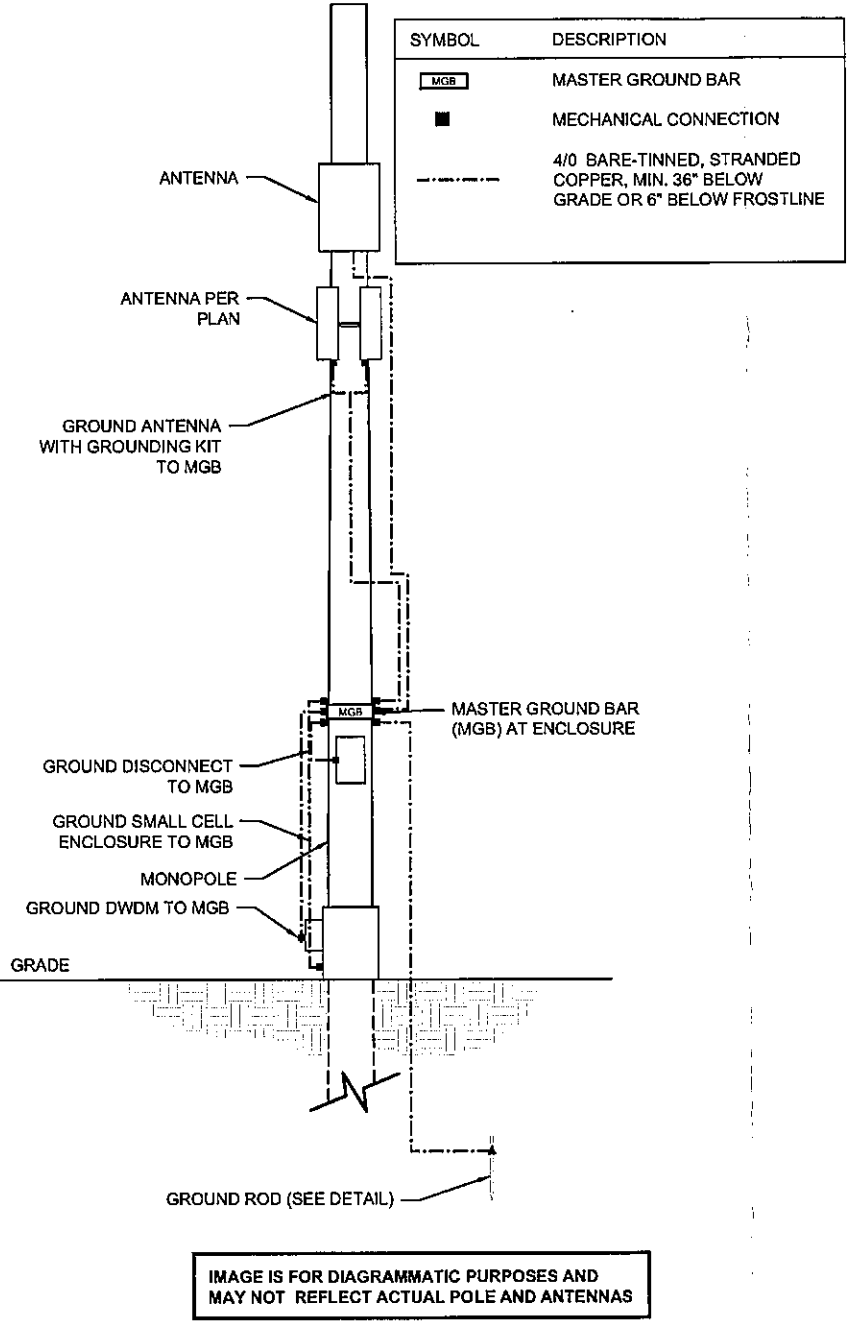
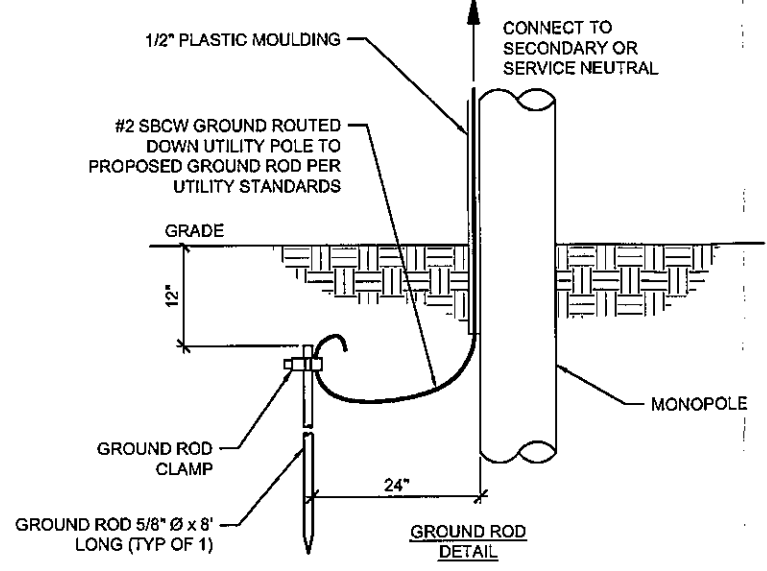

22"x34" SCALE: NOT TO SCALE
11"x17" SCALE: NOT TO SCALE
GROUNDING DIAGRAM 3

PANEL NAME	VERIZON		MANUFACTURER	SQ-D	
VOLTS	120/240		MODEL NUMBER	QO816L100RB	
PHASE	1	WIRE	3	ENCLOSURE RATING	NEMA 4X
BUS RATING	60 AMPS (MAX)		MATERIAL	ALUMINUM	
MAIN BREAKER	60 AMPS		POSITIONS	8 CIRCUITS	

LOAD	POS	BRK	A
4449	1	15	120
8843	2	15	120
RECEPT	3	15	120
HVAC	4	20	120
RACK EQUIP	5	20	120
SPACE	6	--	120
SPACE	7	--	120
SPACE	8	--	120

NOTES:
PANEL IS LOCATED ON EQUIPMENT CABINET

LOAD:

RECEPT	180	8843	320 W
LIGHTING	-0-	4449	120 W
HVAC EQUIP	1500		TOTAL 440 W
TELCO EQUIP	440		
RACK EQUIP	650	TOTAL	2770W

TOTAL LOAD: 2770VA/240V = 11.54A

22"x34" SCALE: NOT TO SCALE
11"x17" SCALE: NOT TO SCALE
PANEL SCHEDULE 3

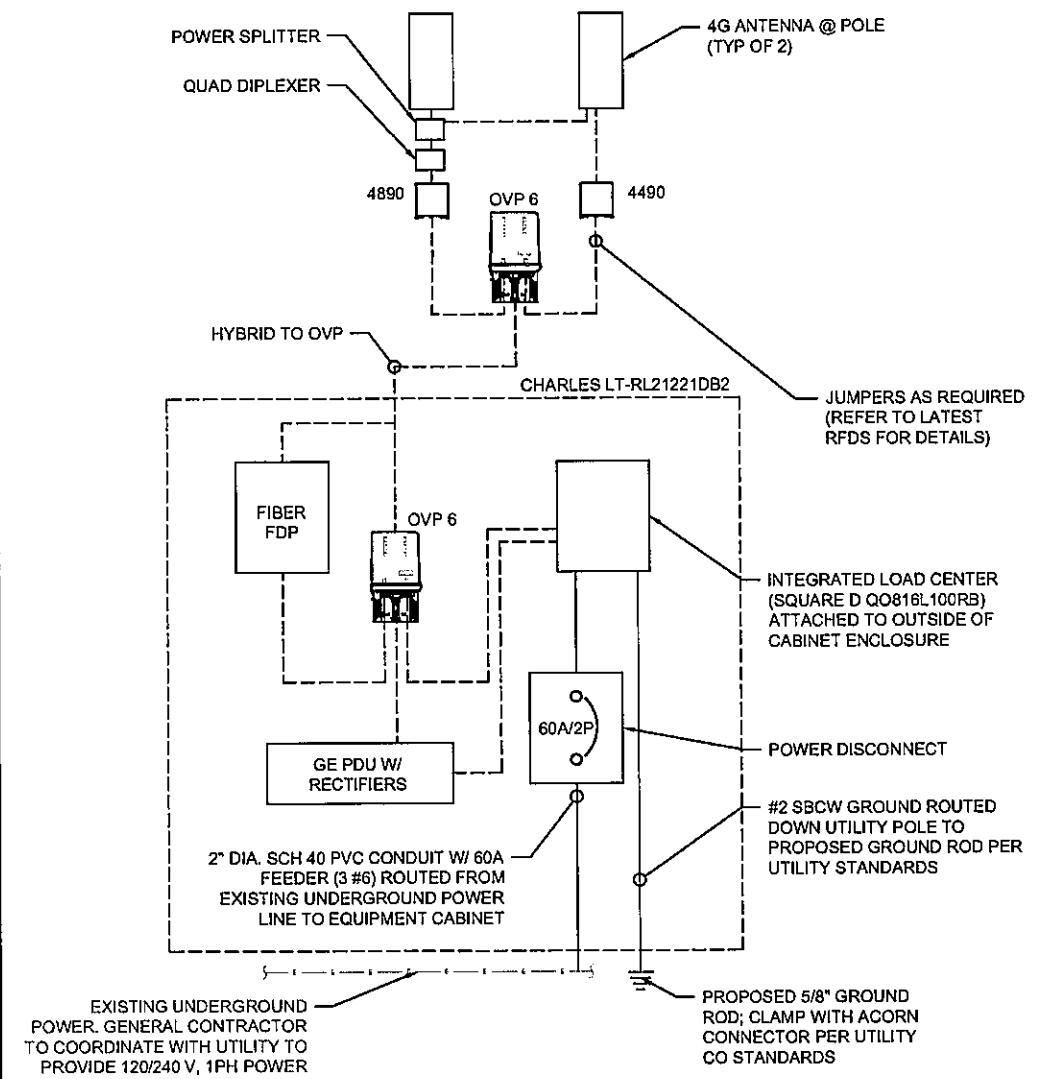

22"x34" SCALE: NOT TO SCALE
11"x17" SCALE: NOT TO SCALE
TYPICAL ONE-LINE DIAGRAM 4

REGISTERED PROFESSIONAL ENGINEER
85663PE
DEAN PAUL LEVORSEN
OREGON
EXPIRES: 12/31/2026
02/11/2025
VSE Project Number: U2350-1241-241

NO.	DATE	DRAWN	REVISION
A	05/22/23	KM	90% PGD REVIEW
B	08/03/23	KM	SURVEY UPDATE
C	06/04/24	KM	RFDS UPDATE
D	12/11/24	DO	100% FINAL CD
1	01/27/25	KM	CLIENT COMMENTS
2	02/11/25	KM	CLIENT COMMENTS

CLIENT:
verizon

A&E CONSULTANT, SITE ACQUISITION AND PERMITTING
Acom
CONSULTING, INC

VECTOR
ENGINEERS

HWY 6
SMALL CELL NODE 07
35300 WILSON RIVER HWY
TILLAMOOK, OR 97141

GROUNDING
DETAILS

E-1.0

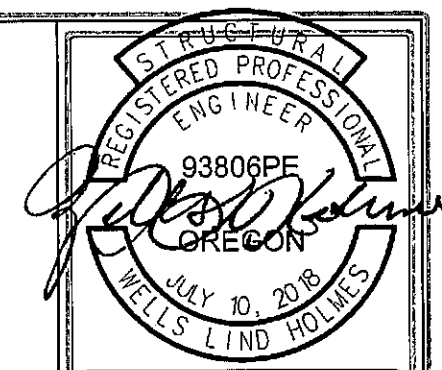

EXPIRES: 6/30/2025

02/11/2025
VSE Project Number: U2350-1241-241

NO.	DATE	DRAWN	REVISION
A	05/22/23	KM	90% PCD REVIEW
B	08/03/23	KM	SURVEY UPDATE
C	06/04/24	KM	RFDS UPDATE
D	12/11/24	DO	100% FINAL CD
1	01/27/25	KM	CLIENT COMMENTS
2	02/11/25	KM	CLIENT COMMENTS



**HWY 6
SMALL CELL NODE 07**
35300 WILSON RIVER HWY
TILLAMOOK, OR 97141

**ANTENNA
CONFIGURATION**

RF-1

**Alpha
(Proposed)**

**Beta
(Proposed)**

